

**OFF-
ROAD
LIVIN'®**



can-am®

**COMMANDER
MAVERICK TRAIL
MAVERICK SPORT**

PRODUCT SPEC BOOK

VEHICLE SPECIFICATIONS - KEY PACKAGES • ACCESSORIES

2022

**OFF-
ROAD
LIVIN'**

2022 COMMANDER, MAVERICK TRAIL & MAVERICK SPORT

VEHICLE SPECIFICATIONS - KEY PACKAGES

FEATURED PACKAGES FOR COMMANDER

Commander DPS 700	6
Maverick Trail 700 T	8
Maverick Sport DPS 1000R T	10

ACCESSORIES

Roofs	14
Soft Cab Enclosure	15
Windshields & Wind Protection	16
Doors	18
Mirrors	19
Commander Skid Plates	20
Maverick Trail & Sport Skid Plates	21
Bumpers & Guards	22
Seat Accessories	27
LinQ: Easy-On, Easy-Off Cargo	28
Cargo & Storage	33
Racks	35
Lights	38
Audio & Communication Systems	42
Electrical & Electronic Accessories	43
Winches & Hitches	47
Performance	50
Apache Track Systems	52
ProMount Plows	54
Trailing	57
Tires & Rims	57

can-am
COMMANDER
MAVERICK TRAIL
MAVERICK SPORT

© 2021 Bombardier Recreational Products Inc. (BRP). All rights reserved. ®, TM and the BRP logo are trademarks of BRP or its affiliates. *All other trademarks are the property of their respective owners. Some models depicted herein may include optional equipment. Prices, if shown, are based on Manufacturer Suggested Retail Prices. Dealers may sell for a different price. For Canada and the US, taxes are not included. Depending on location, products are distributed by BRP US Inc., Bombardier Recreational Products Inc., BRP European Distribution SA, BRP Finland Oy., BRP Australia Pty Ltd. or BRP Brasil Motorsports LTDA. BRP reserves the right, at any time, to discontinue or change specifications, prices, designs, features, equipment without incurring obligation. Printed in Canada.

CAN-AMOFFROAD.COM

VEHICLE
SPECIFICATIONS

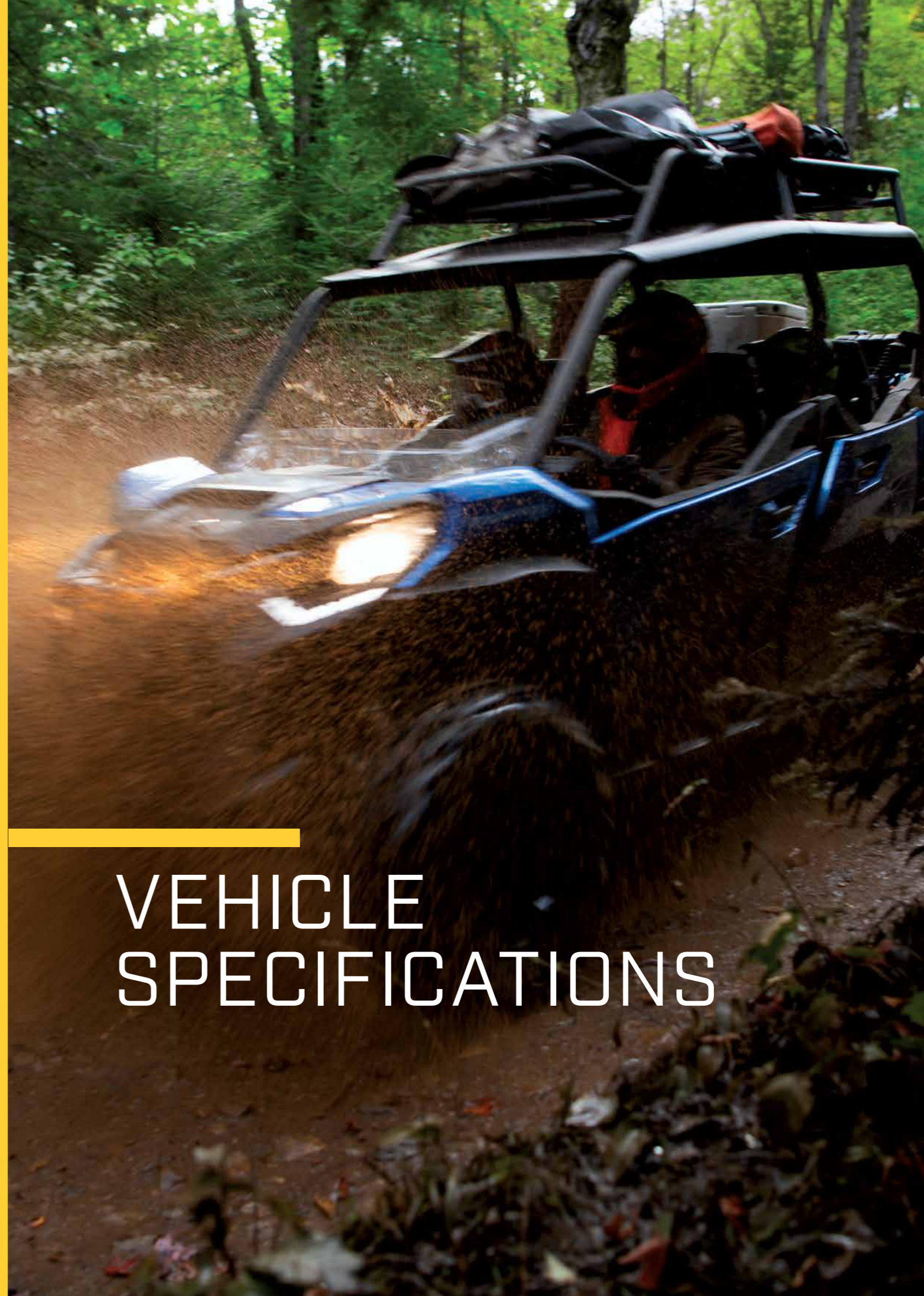

**OFF-
ROAD
LIVIN'**

VEHICLE SPECIFICATIONS - KEY PACKAGES

FEATURED PACKAGES FOR COMMANDER

Commander DPS 700	6
Maverick Trail 700 T	8
Maverick Sport DPS 1000R T	10



COMMANDER DPS 700

HIGHLIGHTS

PERFORMANCE	<ul style="list-style-type: none"> Proven Rotax engine Dependable drivetrain Sport segment worthy suspension
WORKABILITY	<ul style="list-style-type: none"> Rugged taskmaster Work oriented functionality Vehicle protection and rigidity
DESIGN & ERGONOMICS	<ul style="list-style-type: none"> Interior focused on comfort Superior fit and finish Low cost of ownership
PLATFORM FEATURES	<ul style="list-style-type: none"> 90.6 in. (230.1 cm) wheelbase 12.5 in. (31.8 cm) of ground clearance Up to 13 in. (33 cm) suspension travel 2,000 lb (907.2 kg) towing capacity Dynamic Power Steering (DPS™) Visco-Lok† QE front differential SPORT / ECO™ modes RF D.E.S.S. with Start / Stop button Premium half door Mudguard Rear differential with Turf mode 4.5 in. (11.4 cm) digital display

ENGINE	
Type	39 kW (52 hp) / 41 lb-ft, Rotax® ACE (Advanced Combustion Efficiency) 650 cc single cylinder, liquid cooled
Fuel Delivery System	Intelligent Throttle Control (ITC™) with Electronic Fuel Injection (EFI)
Transmission	PDrive primary CVT with engine braking and Electronic Drive Belt Protection L / H / N / R / P
Drive Train	Selectable Turf Mode / 2WD / 4WD with Visco-Lok† QE auto-locking front differential
Driving Assistance	Electronic Hill Descent Control SPORT / ECO™ modes
Power Steering	Dynamic Power Steering (DPS™)

SUSPENSIONS	
Front Suspension	Double A-arm with sway bar / 12.5 in. (31.8 cm) travel
Front Shocks	Twin tube gas charged shocks
Rear Suspension	TTA with sway bar / 13 in. (33 cm) travel
Rear Shocks	Twin tube gas charged shocks

TIRES / WHEELS	
Front Tires	XPS Trail Force 27 x 9 x 14 in. (68.6 x 22.9 x 35.6 cm)
Rear Tires	XPS Trail Force 27 x 11 x 14 in. (68.6 x 27.9 x 35.6 cm)
Wheels	14 in. (35.6 cm) steel

BRAKES	
Front	Dual 220 mm disc brakes with hydraulic twin-piston calipers
Rear	Dual 220 mm disc brakes with hydraulic twin-piston calipers

DIMENSIONS / CAPACITIES	
Estimated Dry Weight *	1530 lb (694 kg)
Chassis / Cage	Profiled cage. ROPS approved
L x W x H	128.5 x 62 x 70.5 in (326.3 x 157.5 x 180.2 cm)
Wheelbase	90.6 in. (230.1 cm)
Ground Clearance	12.5 in (31.8 cm)
Cargo Box Dimension	29.5 x 45.2 x 10.6 in. (75.1 x 114.7 x 27 cm)
Cargo Box Capacity	600 lb (272.2 kg)
Towing Capacity	2000 lb (907.2 kg)
Payload Capacity	1030 lb (467.2 kg)
Storage Capacity	Total: 7.3 gal (27.6 L) Glove Box: 4.1 gal (15.6 L) Driver storage: 0.4 gal (1.5 L) Center console and Cup holders: 0.8 gal (3.1 L) Side Cargo Box storage (passenger side): 1.6 gal (5.9 L) Dual-side panel storage: 0.8 gal (3.0 L)
Fuel Capacity	10 gal (38 L)

FEATURES	
Gauge	4.5 in. (11.4 cm) wide digital display: Speedometer, tachometer, odometer, trips and hour meters, fuel, gear position, SPORT / ECO™ mode, seat belt and 4 x 4 indicator, rear diff lock indicators, diagnostics, clock, battery voltage, engine temperature
Instrumentation	Lighter type DC outlet in console (10-A)
Anti-theft System	RF Digitally Encoded Security System (D.E.S.S.™) with Start / Stop button
Magneto	650-W
Lighting	Two 55 W reflectors headlights (low/High) and LED tail lights
Winch	N/A
Steering Wheel	Adjustable tilt steering
Protection	Premium half doors Full skid plate Mudguards
Hitch Type	2-in hitch receiver

WARRANTY & EXTENDED SERVICE	
Factory warranty	2-year BRP limited warranty



Tundra Green

FEATURE HIGHLIGHTS



Powerful Rotax Engine

The new Rotax ACE 650-cc single cylinder engine is built to exceed expectations. With 52 horsepower and 41 lb-ft behind it, this engine delivers responsive power and torque from the moment riders put their hands on the wheel.



Powerhouse on Wheels

Towing capacity is one thing—the Can-Am Commander DPS 700's astounding 2,000 lb (907.2 kg) of it is another. Naturally, that's best in its segment.



Toughness in a Tire

The Can-Am Commander DPS 700 sits on 27-inch XPS Trail Force tires. These tires are built to perform well in all conditions. Weather shouldn't get in the way of a ride: it should encourage one.



Styled for the Long Haul

For the driver, an adjustable seat and tilt steering wheel. Passengers enjoy wider opening half-doors and comfortable bucket seats. It's a big world out there—the Commander DPS 700 is ready for it.



Big Where It Counts

At more than 8 cubic feet and with a 600 lb (272.2 kg) capacity, the largest dumping cargo box in its class laughs in the face of dirt, mulch, rocks, and more.



Anti-Theft Protection

A ride this special deserves heightened security. Encrypted chip technology—one vehicle, one key, one code—restricts access to only the owner. The electronic ignition system and ball-and-socket key design team up for a reliable wireless connection. Additional keys, programmed for other riders, can be added at any time.



Trip Info at Your Fingertips

The 4.5-inch digital display keeps the Can-Am Commander DPS 700's crucial information at hand. Features include speedometer, gear position, temperature, engine lights control, electronic fuel gauge, clock, and more.

MAVERICK TRAIL 700 T

HIGHLIGHTS

AGILE	<ul style="list-style-type: none"> Sturdy engine and transmission Easy Handling and capabilities Front and rear suspension designed for trail riding
ADVENTUROUS	<ul style="list-style-type: none"> Meaningful functionalities and versatilities Enhanced comfort with Ergo-Lok cockpit Build your Maverick Trail that fits your needs
CONFIDENT	<ul style="list-style-type: none"> Can-Am design and proven fit & finish Enhanced protection More adventure and less maintenance
PLATFORM FEATURES	<ul style="list-style-type: none"> 62.8 in. (159.6 cm) wide 90.6 in. (230.1 cm) wheelbase 10 in. (25.4 cm) of ground clearance Up to 10.5 in. (26.7 cm) suspension travel 7.6 in. (19.3 cm) wide digital display with keypad SPORT / ECO™ modes Ergoprint seats Net (instead of doors) RF key DESS with Start / Stop button Mudguard and Mudflap Rear hitch and tow ball 7-pin trailer connexion (12V) LED tail lights with halo glow effect Horn, flashers and position lamps, left/right mirrors, license plate support, hook on front metal bumper, driver seat detector, Low brake fluid sensor

ENGINE	
Type	39 kW (52 hp) / 41 lb-ft, Rotax® ACE (Advanced Combustion Efficiency) 650 cc single cylinder, liquid cooled, with catalytic converter
Fuel Delivery System	Intelligent Throttle Control (ITC™) with Electronic Fuel Injection (EFI)
Transmission	PDrive primary CVT with engine braking and Electronic Drive Belt Protection L / H / N / R / P
Drive Train	Selectable 2WD / 4WD with Visco-Lok† auto-locking front differential
Driving Assistance	Electronic Hill Descent Control SPORT / ECO™ modes
Power Steering	N/A

SUSPENSIONS	
Front Suspension	Double A-arm with sway bar / 10 in. (25.4 cm) travel
Front Shocks	Twin tube gas charged shocks
Rear Suspension	TTA with sway bar / 10.5 in. (26.7 cm) travel
Rear Shocks	Twin tube gas charged shocks

TIRES / WHEELS	
Front Tires	Carlisle ACT 26 x 8 x 12 in. (66 x 20.3 x 30.5 cm)
Rear Tires	Carlisle ACT 26 x 9 x 12 in. (66 x 22.9 x 30.5 cm)
Wheels	12 in. (30.5 cm) steel

BRAKES	
Front	Dual 220 mm disc brakes with hydraulic twin-piston calipers
Rear	Dual 220 mm disc brakes with hydraulic twin-piston calipers

DIMENSIONS / CAPACITIES	
Estimated Dry Weight *	1,256 lb (569.7 kg)
Chassis / Cage	Profiled cage ROPS approved
L x W x H	118 x 62.8 x 69 in. (300.5 x 159.6 x 175.3 cm)
Wheelbase	90.6 in. (230.1 cm)
Ground Clearance	10 in. (25.4 cm)
Cargo Box Capacity	300 lb (136 kg)
Towing Capacity	1,500 lb (682 kg)
Storage Capacity	Total: 5.3 gal (20.2 L) Glove Box: 4.1 gal (15.6 L) Driver storage: 0.4 gal (1.5 L) Center console and Cup holders: 0.8 gal (3.1 L)
Fuel Capacity	10 gal (38 L)

FEATURES	
Gauge	7.6 in. (19.3 cm) wide digital display with keypad, Speedometer, tachometer, odometer, trips and hour meters, fuel, gear position, SPORT / ECO™ mode, seat belt and 4 x 4 indicator, front and rear diff lock indicators, diagnostics, clock, battery voltage, engine temperature
Instrumentation	Lighter type DC outlet in console (20-A)
Anti-theft System	RF Digitally Encoded Security System (D.E.S.S.™) with Start / Stop button
Magneto	650-W
Lighting	Two 55 W reflectors and LED tail lights with halo glow effect
Winch	N/A
Steering Wheel	Adjustable tilt steering
Protection	Integrated front steel bumper, Full skid plate Mudguard and Mudflap
Hitch Type	2 in. hitch receiver with rear hitch and tow ball

WARRANTY	
Factory warranty	2-year BRP limited warranty



Can-Am Red

FEATURE HIGHLIGHTS



Powerful Rotax Engine

The new Rotax ACE 650-cc single cylinder engine is built to exceed expectations. With 52 horsepower and 41 lb-ft behind it, this engine delivers responsive power and torque from the moment riders put their hands on the wheel.



Uncompromised Comfort

This trail-sized side-by-side sports a 65-inch wide cockpit that makes the most of its size. Ergo-Lok design provides all the space needed for two riders to get comfortable—even if the journey leads them out of their comfort zone.



Trip Info at Your Fingertips

Everything needed to control the perfect ride is on the Can-Am Maverick Trail's 7.6-inch (19.3 cm) digital screen. At that size, it's readable in all conditions and puts all the vehicle's information and controls at the tip of the driver's gloves.



Suited for Adventure

Strong, well-engineered, and braced for battle. A profiled steel cage, integrated front bumper, and full skid plates give the Maverick Trail a set of armor for the trails.

MAVERICK SPORT DPS 1000R T

HIGH-LIGHTS

DARING	<ul style="list-style-type: none"> Sturdy engine and transmission Enhanced comfort and meaningful functionalities Can-Am Design
PRECISE	<ul style="list-style-type: none"> Easy handling and capabilities Suspension designed for performance Ultra-resistant chassis
CONFIDENT	<ul style="list-style-type: none"> Perfectly tuned Enhanced protection More adventure and less maintenance
PLATFORM FEATURES	<ul style="list-style-type: none"> 62.1 in. (157.8 cm) wide 90.6 in. (230.1 cm) wheelbase 12 in. (30.5 cm) of ground clearance Up to 12 in. (30.5 cm) suspension travel SHOWA 2.0 shocks SPORT / ECO™ modes RF D.E.S.S. with Start / Stop button Mudguards

SPECIFIC TO DPS T PACKAGE	<ul style="list-style-type: none"> Dynamic Power Steering (DPS™) 62 in. (157.8 cm) wide Ergoprint seats with color accents Lockable rear differential 28 in. (71.1 cm) Maxxis Liberty† tires 7.6 in. (19.3 cm) wide digital display with keypad Mudflaps Rear hitch and tow ball 7-pin trailer connexion (12V) Net (instead of doors) LED tail lights with halo glow effect Horn, flashers and position lamps, lateral mirrors, license plate support, hook on front metal bumper, driver seat detector, brake main cylinder sensor and new exhaust Dynamic Brake Control (ABS + HHC + HDC) Dynamic Traction Control (BTC + DTC) - TCS can be switched off
----------------------------------	--



■ Triple Black

ENGINE	
Type	71 kW (95 hp), Rotax® 976 cc, V-twin, liquid cooled, catalyst
Fuel Delivery System	Intelligent Throttle Control (ITC™) with Electronic Fuel Injection (EFI)
Transmission	Quick Response System (QRS) CVT with high airflow ventilation and Electronic Drive Belt Protection Extra-L / H / N / R / P
Drive Train	Selectable 2WD / 4WD with Open front diff. with Brake Traction Control (BTC) / Lockable rear differential
Driving Assistance	Electronic Hill Descent Control SPORT / ECO™ modes
Power Steering	Dynamic Power Steering (DPS)

SUSPENSIONS	
Front Suspension	Double A-arm with sway bar / 11.5 in. (29.2 cm) travel
Front Shocks	SHOWA 2.0
Rear Suspension	TTA with sway bar / 12 in. (30.5 cm) travel
Rear Shocks	SHOWA 2.0

TIRES / WHEELS	
Front Tires	Maxxis Liberty† 28 x 10 x 14 in. (71.1 x 22.9 x 35.6 cm)
Rear Tires	Maxxis Liberty† 28 x 10 x 14 in. (71.1 x 22.9 x 35.6 cm)
Wheels	14 in. (35.6 cm) cast-aluminum

BRAKES	
Front	Dual 220 mm disc brakes with hydraulic twin-piston calipers and Dynamic Brake Control (ABS + HHC + HDC)
Rear	Dual 220 mm disc brakes with hydraulic twin-piston calipers and Dynamic Brake Control (ABS + HHC + HDC)

DIMENSIONS / CAPACITIES	
Estimated Dry Weight *	1,405 lb (637.3 kg)
Chassis / Cage	Profiled cage. ROPS approved
L x W x H	119 x 62.1 x 76.1 in. (302.2 x 157.8 x 193 cm)
Wheelbase	90.6 in. (230.1 cm)
Ground Clearance	12 in. (30.5 cm)
Cargo Box Capacity	300 lb (136 kg)
Towing Capacity	1,500 lb (682 kg)
Storage Capacity	Total: 5.3 gal (20.2 L) Glove Box: 4.1 gal (15.6 L) Driver storage: 0.4 gal (1.5 L) Center console and Cup holders: 0.8 gal (3.1 L)
Fuel Capacity	10 gal (38 L)

FEATURES	
Gauge	7.6 in. (19.3 cm) wide digital display with keypad: Speedometer, tachometer, odometer, trips and hour meters, fuel, gear position, SPORT / ECO™ mode, seat belt and 4 x 4 indicator, front and rear diff lock indicators, diagnostics, clock, battery voltage, engine temperature
Instrumentation	Lighter type DC outlet in console (20-A)
Anti-theft System	RF Digitally Encoded Security System (D.E.S.S.™) with Start / Stop button
Magneto	650-W
Lighting	Two 55 W reflectors and LED tail lights with halo glow effect
Winch	N/A
Steering Wheel	Adjustable tilt steering
Protection	Integrated front steel bumper Full skid plate Mudguards Mudflaps
Hitch Type	2-in hitch receiver with rear hitch and tow ball

WARRANTY	
Factory warranty	2-year BRP limited warranty

FEATURE HIGHLIGHTS



Powerful Rotax Engine

The Rotax 976 V-Twin engine is built to exceed expectations. With 75 horsepower behind it, this engine delivers more punch from the moment riders put their hands on the wheel.



Serious Suspension for Serious Riders

All-new SHOWA 2.0 shocks get riders through extreme terrain with confidence. These new shocks give the Maverick Sport the perfect blend of agility and all-day comfort.



Two Driving Modes

The Can-Am Maverick Sport offers two distinct driving modes. ECO Mode softens the throttle progression for better control in choppy terrain. SPORT Mode ramps it up for a maximum response.



Trip Info at Your Fingertips

The 4.5-inch digital display keeps the Can-Am Maverick Sport's crucial information at hand. Features include speedometer, gear position, temperature, engine light control, electronic fuel gauge, clock, and more.

All-Terrain Protection

Strong, well-engineered, and braced for battle. The Maverick Sport's integrated front steel bumper, premium half doors, full skid plate, and mudguards tackle tough terrain—and keep safety front and center.

ACCESSORIES

Roofs	14	Racks	35
Soft Cab Enclosure	15	Lights	38
Windshields & Wind Protection	16	Audio & Communication Systems	42
Doors	18	Electrical & Electronic Accessories	43
Mirrors	19	Winches & Hitches	47
Commander Skid Plates	20	Performance	50
Maverick Trail & Sport Skid Plates	21	Apache Track Systems	52
Bumpers & Guards	22	ProMount Plows	54
Seat Accessories	27	Trailer	57
LinQ: Easy-On, Easy-Off Cargo	28	Tires & Rims	57
Cargo & Storage	33		

MAKE IT YOURS.



FIT AND COMPATIBILITY

For us, innovation is a no-brainer. All our accessories work together, right out of the box. So take your pick. Then pick some more.



STYLE AND VISION

We've upped the ante when it comes to accessories. Not just designed to look good, but perform right for real riders. All killer, no filler.



QUALITY AND RELIABILITY

Our Can-Am accessories are made right the first time. And to top it off we threw in a 1-year warranty. You're welcome. Install them yourself or at an authorized dealer.

BRP 2-YEAR LIMITED WARRANTY*

For new Can-Am accessories, genuine parts, and co-branded products sold through BRP. Includes items installed by you or an authorized BRP dealer.

can-am

*Use other than which the product is designed for will void the product limited warranty. Other exclusions may apply, the warranty is subject to the exclusions, limitations of liabilities and all other terms and conditions of BRP's standard limited warranty. See complete limited warranty or contact your Can-Am Off-Road authorized dealer. Applies only to BRP-made products or co-branded products made by currently accredited BRP partners. Purchased at an authorized BRP dealership/distributor or from a BRP-authorized online store. Unless otherwise stipulated or required by law. This limited warranty does not apply to factory installed accessories. This limited warranty does not apply on Evinrude parts and accessories. This limited warranty is effective as of March 1, 2016.

ROOFS

	Commander	715007271 NEW
	Commander MAX	715007272 NEW
	Maverick Trail, Maverick Sport	715006218
	Maverick Sport MAX	715004704

Sport Roof



- Excellent protection from the elements.
- Allows installation of lights on top of the roof.
- Compatible with all windshields.

ProVent Roof Module Kit

Commander, Maverick Trail, Maverick Sport	715005279
--	------------------



- Provides fresh air in the cab area.
- Optimal performance with full cab enclosure.
- 4 vents provide infinite adjustment of air flow for driver and passenger.
- Filter and pre-filter to limit dust intrusion.
- Easy cleaning of filter and pre-filter.
- Patent pending water management system to keep water out of cabin while maintaining air flow.
- Outer plug closes air intake completely for winter or heavy weather.
- Requires ProVent Roof Module Adaptor Kit for Sport Roof.
- Not compatible with roof mounted LED bars, roof racks, roof liners, Bimini Roof, DragonFire Roof and Lonestar Racing Roof.

ProVent Roof Module Adaptor Kit for Sport Roof *(Not illustrated)*

Commander, Maverick Trail, Maverick Sport	715005213
--	------------------

- Adaptor for fitting ProVent Roof Module Kit onto Commander, Maverick Sport or Maverick Trail Sport Roof.
- Includes roof adapter and hardware.
- Requires ProVent Roof Module Kit (715005279).

Bimini[†] Roof with Sun Visor

Commander, Maverick Trail, Maverick Sport [†]	715003661
Commander MAX, Maverick Sport MAX	715004792



- Heavy-duty canvas made of UV-resistant solution-dyed polyester.
 - Soft top comes with a hard visor that allows for storage of rolled-up soft top and mounting auxiliary lights.
- †Not compatible with Glass Windshield with wiper.*

DragonFire[†] Aluminum Roof

Commander, Maverick Trail, Maverick Sport	715004458
Commander MAX, Maverick Sport MAX	715004891



- Durable and lightweight formed aluminum roof with durable powder coat finish.
- Sleek lines designed to match your vehicle's body and greatly enhance the overall look.
- Compatible with Half Windshield and Full Windshield Hardcoated only.

Lonestar Racing[†] Aluminum Roof

Commander, Maverick Trail, Maverick Sport [†]	■ 715005137 • Black ■ 715003831 • Can-Am Red
Commander MAX, Maverick Sport MAX	■ 715004892 • Can-Am Red



- Race-true low profile look with integrated front visor for eye-popping performance and protection.
- 0.083" (2.1 mm) thick aluminum roof for durable and lightweight protection from the elements.
- Compatible with Lonestar Racing Mounts for 39" (99 cm) Double Stacked LED Light Bar (715004877).
- Not compatible with Full Windshields, Rigid Rear Window, Can-Am Intrusion Bars and Overhead Switch Panel.

SOFT CAB ENCLOSURE

Soft Cab Enclosure

Maverick Trail	715003618
----------------	------------------



- Includes:
- Sport Roof.
 - Full Windshield – Hardcoated.
 - Upper Soft Door Panels.
 - Soft Rear Panel.
 - Door Seal kit.
 - Requires Half Doors on 800 Base and 800 DPS models, and on all T-category models.
 - Not compatible with Sport Half Doors.

Soft Cab Enclosure *(Not illustrated)*

Commander, Maverick Trail, Maverick Sport (Except X mr models)	715004724
--	------------------

- Can be installed on the Maverick Trail equipped with the Sport Half Doors or on Maverick Sport models.
- Includes:
- Sport Roof.
 - Full Windshield – Hardcoated.
 - Upper Soft Door Panels.
 - Soft Rear Panel.
 - Sport Half Doors required on all T-category models.

Soft Cab Enclosure

Commander MAX, Maverick Sport MAX (Except X mr models)	715004725
--	------------------



- Includes:
- Sport Roof.
 - Full Windshield – Hardcoated.
 - Upper Soft Door Panels.
 - Soft Rear Panel.
 - Sport Half Doors required on all T-category models.





Semi-Rigid Cab Enclosure *(Not illustrated)*







Commander, Maverick Trail, Maverick Sport (Except X mr models)	619400119
--	------------------

- Can be installed on the Maverick Trail equipped with the Sport half doors or on Maverick Sport models.
- Sport Half Doors required for T-category models.

- Sport roof
- Glass Windshield with Wiper
- Overhead Switch Panel
- Upper Soft Door Panels
- Rear Polycarbonate Window

WINDSHIELDS & WIND PROTECTION

WINDSHIELDS		
Glass Windshield 	Commander, Commander MAX, Maverick Trail, Maverick Sport, Maverick Sport MAX	715003653
<ul style="list-style-type: none"> • Curved and laminated glass full windshield in metal frame. • Provides excellent optical clarity. • Seals firmly against the cage and protects rider and passenger from the elements. • Must be used with a rear wind protection. • Not EC compliant. 		
Glass Windshield with Wiper <i>(Not illustrated)</i>	Commander, Commander MAX, Maverick Trail, Maverick Sport, Maverick Sport MAX	715003652
<ul style="list-style-type: none"> • Curved and laminated glass full windshield in metal frame. • Provides excellent optical clarity. • Seals firmly against the cage and protects rider and passenger from the elements. • Single-speed wiper with washer fluid dispenser. • Requires the Overhead Switch Panel (715003669) for installation. • Must be used with rear wind protection. • Not EC compliant. 		
Windshield Wiper and Washer Kit 	Commander, Commander MAX, Maverick Trail, Maverick Sport, Maverick Sport MAX	715003654
<ul style="list-style-type: none"> • An ideal way to keep your windshield clear in rain, or while riding through mud and water. • Includes single-speed wiper, washer fluid dispenser and windshield frame mount. • Must be used with the Glass Windshield (715003653). • Requires Overhead Switch Panel (715003669) for installation. • Not EC compliant. • Not compatible with ABS equipped vehicles. 		
Half Windshield 	Commander, Commander MAX, Maverick Trail, Maverick Sport, Maverick Sport MAX	<input type="checkbox"/> 715003657 • Clear <input checked="" type="checkbox"/> 715005280 • Tinted
<ul style="list-style-type: none"> • Formed polycarbonate construction for enhanced rigidity. • Formulated to be non-yellowing, non-crazing, non-cracking with excellent UV resistance and optical clarity. • Protects driver and passenger from the elements. • Features reverse angle lip to deflect air flow. • Quick and easy tool-less installation or removal. 		
Full Windshield 	Commander, Commander MAX, Maverick Trail, Maverick Sport, Maverick Sport MAX	715003655
<ul style="list-style-type: none"> • High-impact-resistant durable polycarbonate full windshield. • Formed polycarbonate construction for enhanced rigidity. • Formulated to be non-yellowing, non-crazing, non-cracking with excellent UV resistance and optical clarity. • Seals firmly against the cage and protects rider and passenger from the elements. • Recommended to use with rear wind protection. • Quick and easy tool-less installation or removal. 		
Full Windshield - Hardcoated 	Commander, Commander MAX, Maverick Trail, Maverick Sport, Maverick Sport MAX	715003656
<ul style="list-style-type: none"> • High-impact-resistant Quantum¹ hardcoated polycarbonate full windshield. • Formed polycarbonate construction for enhanced rigidity. • Provides excellent optical clarity and better abrasion resistance. • Seals firmly against the cage and protects rider and passenger from the elements. • Recommended to use with rear wind protection. • Quick and easy tool-less installation or removal. 		

ProVent Windshield 	Commander, Commander MAX, Maverick Trail, Maverick Sport, Maverick Sport MAX	715005210
<ul style="list-style-type: none"> • High-impact-resistant Quantum¹ hardcoated polycarbonate full windshield. • Controllable vents to manage air flow. • Channels air into the cabin, defogs windshield, fully closes to eliminate air flow. • One upper vent and one lower vent with pre-filters. • Provides excellent optical clarity and better abrasion resistance. • Protects driver and passenger from the elements. • Quick and easy tool-less installation or removal. • Not compatible with wiper kits and Wet Sounds Stealth 6 Ultra HD Can-Am Edition Sound Bar. 		
PowerFlip Windshield 	Commander, Commander MAX, Maverick Trail, Maverick Sport, Maverick Sport MAX	715003658
<ul style="list-style-type: none"> • The PowerFlip Windshield is equipped with electric cylinders that allow the rider to adjust the windshield opening at the touch of a button. • Windshield is made of hardcoated polycarbonate with a rubber seal contour and a tinted top section. • Allows you to quickly adapt to changing conditions by adjusting the windshield as you go. • Can be fully opened for optimal visibility and ventilation, fully closed for maximum protection from the elements, and in between, you have an infinite number of openings. 		
WIND PROTECTION		
Side Wind Deflectors 	Maverick Trail (models produced before January 19, 2021), Maverick Sport, Maverick Sport MAX (models produced before January 19, 2021)	715004310
<ul style="list-style-type: none"> • Clear polycarbonate air deflectors mount on each side of the cage. • Can be adjusted to three different positions for cabin air flow control when full windshield is installed: <ul style="list-style-type: none"> - 1) Outside deflection to reduce cabin air flow and turbulence. - 2) Inside deflection to increase air flow in the cabin. - 3) Windshield ventilation to reduce fog. • Compatible with all windshields. • Not compatible with full doors. • Sold in pairs. 		
Rear Polycarbonate Window 	Commander, Commander MAX, Maverick Trail, Maverick Sport, Maverick Sport MAX (Except X mr models)	715006113
<ul style="list-style-type: none"> • High-impact-resistant polycarbonate window. • Blocks windshield backdraft or dust and rain from entering for added cabin comfort. • Sport Roof is required for installation. • Not compatible with Bimini Roof with Sun Visor, DragonFire Aluminum Roof and Lonestar Racing Aluminum Roof. 		
Rear Wind Screen 	Commander, Commander MAX, Maverick Trail, Maverick Sport, Maverick Sport MAX (Except X mr models)	715003664
<ul style="list-style-type: none"> • Full rear mesh screen reduces windshield backdraft for added cabin comfort. • Installs quickly and easily on roll cage. • Large Can-Am branding. 		
Soft Rear Panel 	Commander, Commander MAX, Maverick Trail, Maverick Sport, Maverick Sport MAX (Except X mr models)	715005887
<ul style="list-style-type: none"> • Plastic reinforced and weather-resistant rear panel offers good protection from the elements. • Made of heavy-duty UV-resistant solution-dyed polyester canvas for excellent resistance to tear and abrasion. • Clear window made of laminated polished vinyl material. • Resists cold cracking. • Installs quickly and easily on roll cage. 		

DOORS

Trail Half Doors	Maverick Trail	715004418
-------------------------	----------------	------------------



- Half doors made of molded polypropylene to match vehicle's styling.
- Steel frame for high level of rigidity.
- A must-have for additional cabin comfort.
- Keep the vehicle narrow in tight trail riding conditions.
- Door Trim is required to complete your door kit (sold separately).
- Standard on 1000 Base and 1000 DPS models.
- Sold in pairs.

Door Trim	Maverick Trail	<ul style="list-style-type: none"> ■ Can-Am Red ■ Timeless Black ■ Octane Blue 	Left 705015450 705015607 705016447	Right 705015451 705015613 705016449
------------------	----------------	---	--	---



- Matching colored panel for Trail Half Doors.
- Required to complete the Trail Half Doors (sold separately).

Sport Half Doors	Commander, Commander MAX, Maverick Trail, Maverick Sport, Maverick Sport MAX	715006217
-------------------------	--	------------------



- Half doors made of molded polypropylene to match vehicle's styling.
- A must-have for additional cabin comfort.
- Features rounded shape to increase cabin space.
- Standard on all Commander & Maverick Sport models.
- Can be installed on Maverick Trail models for additional cabin space.
- Door Trim is required to complete your door kit (sold separately).
- Sold in pairs.

Door Trim	Commander, Commander MAX, Maverick Trail, Maverick Sport, Maverick Sport MAX	<ul style="list-style-type: none"> ■ Can-Am Red ■ Timeless Black ■ Octane Blue 	Left 705015464 705015608 705016448	Right 705015465 705015615 705016450
------------------	--	---	--	---



- Matching colored panel for the Sport Half Doors.
- Required to complete the Sport Half Doors (sold separately).
- Sold in pairs.

Upper Soft Door Panels	Commander, Maverick Trail [†] , Maverick Sport,	715004718
	Commander MAX, Maverick Sport MAX [†]	715004727



- Upper canvas portion of the doors with sturdy steel frame.
- Seals firmly against the cage and protects rider and passenger from the elements.
- Converts half door into full door for a complete cab enclosure.
- Zippered window made of laminated polished vinyl material for added ventilation.
- Easy to remove on hot and sunny days.

[†]Not compatible with Trail Half Doors or with the standard half doors on Maverick Trail models.
[#]Includes Upper Soft Door Panels for front and rear doors.

Upper Soft Door Panels <i>(Not illustrated)</i>	Maverick Trail	715003620
---	----------------	------------------

- Can only be installed with Trail Half Doors or with the standard half doors on Maverick Trail models.
- Not compatible with Sport Half Doors or with the standard half doors on Maverick Sport models.

Door Seal Kit <i>(Not illustrated)</i>	Maverick Trail	715004773
--	----------------	------------------

- Improves door sealing from the elements and provides additional cabin comfort.
- Included in the Soft Cab Enclosure kit (715003618).
- Not compatible with Sport Half Doors.
- Compatible with the Trail Half Doors or with the stock doors on the Maverick Trail.

Door Knee Pads with Storage	Maverick Trail	715003635
------------------------------------	----------------	------------------



- Padded door cushion with integrated pocket for storage.
- Protect driver and passenger legs from direct contact with the doors while riding.
- Increase cabin comfort.
- Require Trail Half Door on 800 Base and 800 DPS models (715004418).
- Offer storage space for small items.
- Sold in pairs.
- Not compatible with Sport Half Doors.

Door Storage with Padding	Commander, Commander MAX, Maverick Trail, Maverick Sport, Maverick Sport MAX	715004914
----------------------------------	--	------------------



- Weather-resistant door storage bags with integrated padding.
- Holds your gear safely and securely and also protects driver and passenger legs from direct contact with the doors while riding.
- Each bag is designed as a 0.5 gal (2 L) capacity pocket also equipped with inner netting compartments.
- Semi-rigid construction renders them flexible enough to fit odd-shaped loads.
- Easy to install.
- Sold in pairs.
- Bags attach on stock doors of the Maverick Sport or on the Maverick Trail equipped with the Sport Half Doors (715006217).
- Not compatible with stock doors on the Maverick Trail or the Trail Half Doors.

MIRRORS

Panoramic Center Mirror	Commander, Commander MAX, Maverick Trail, Maverick Sport, Maverick Sport MAX	715003638
--------------------------------	--	------------------



- Wide-angle convex mirror.
- Offers enhanced visibility.
- Can be used with or without roof or windshield and with cab enclosure.

Sport Panoramic Center Mirror	Commander, Commander MAX, Maverick Trail, Maverick Sport, Maverick Sport MAX	715004924
--------------------------------------	--	------------------



- Convex mirror for wide rearward visibility.
- Ball-joint design with tightening knob for steady multi-angle adjustment.
- Can be used with or without roof or windshield.
- Not for road use.

Rear View Mirror and Camera Monitor	Commander, Commander MAX, Maverick Trail, Maverick Sport, Maverick Sport MAX	715004905 • Black
--	--	--------------------------



- Fully waterproof rear view camera and monitor kit.
- Multiple camera feeds can be seen with the rear view camera, to see what you need.
- Unit replaces stock rear view mirror (screen is integrated in the unit's replacement rear view mirror).
- Camera uses infrared light for night vision capabilities.

COMMANDER

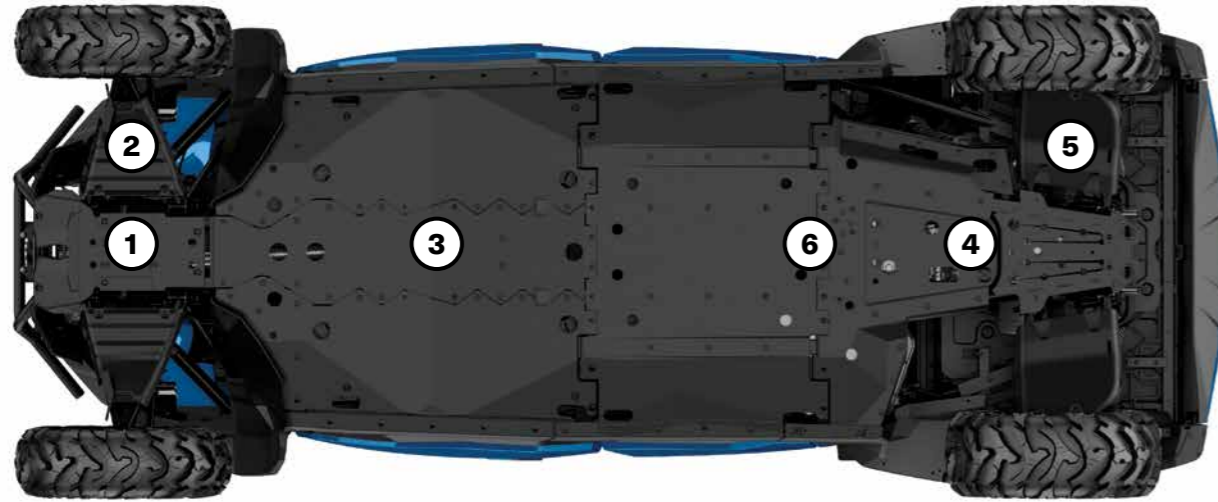

Our plastic plates glide smoothly and silently over obstacles, offering great protection in rough terrain.

- Made of abrasion-resistant thermoformed High Molecular Weight Polyethylene (HMWPE).
- Lighter than aluminum.
- Superior stress crack resistance.
- High impact strength.
- Ultra-sturdy 3/8" (10 mm) thickness.

Offer your Commander the full protection kit or get parts individually	COMMANDER, COMMANDER MAX	
	DPS & XT 700	XT 1000, XT-P & X mr
HMWPE SKID PLATE PROTECTION KIT		
• Includes: - HMWPE Front Skid Plate. - HMWPE Front A-Arm Protectors. - HMWPE Rear Skid Plate. - HMWPE Rear A-Arm Protectors. - HMWPE Underbelly Plates. - HMWPE Central Skid Plate.	715006349 (Except MAX)	715006350 (Except MAX)
	715006351 (MAX Only)	715007303 (MAX Only)
INDIVIDUAL HMWPE SKID PLATES		
① HMWPE Front Skid Plate	715008279	715008279
② HMWPE Front A-Arm Protectors	715008276	715008277
③ HMWPE Underbelly Plates <i>Keeps the rollover clearance.</i>	715006273	715006273
④ HMWPE Rear Skid Plate	715007302	715007302
⑤ HMWPE Rear A-Arm Protectors	715004271	715006341
⑥ HMWPE Central Skid Plate <i>Provides center protection for MAX models.</i>	715004272 (MAX Only)	715004272 (MAX Only)

MAVERICK TRAIL & MAVERICK SPORT

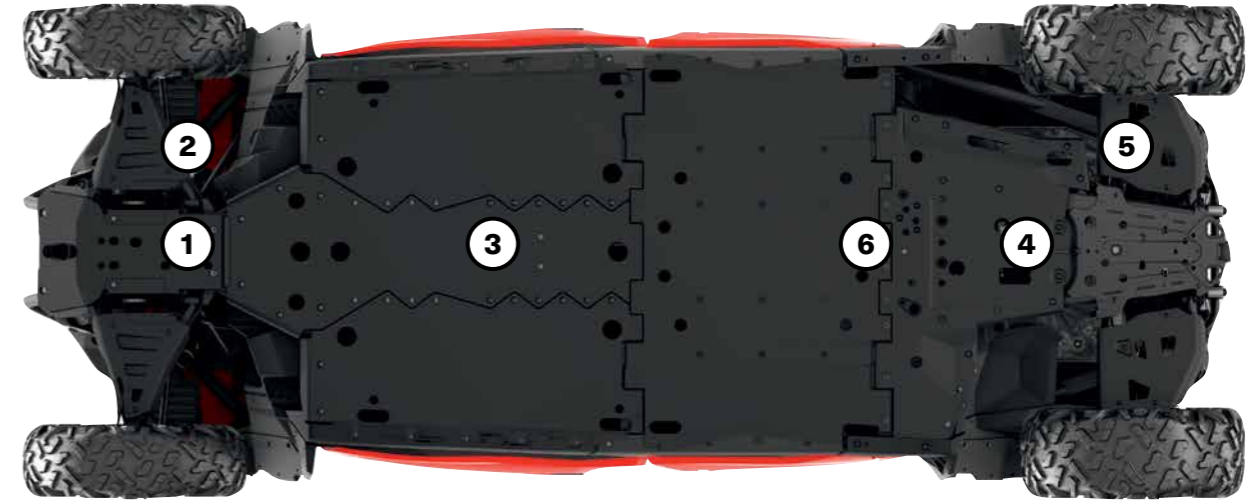

Our plastic plates glide smoothly and silently over obstacles, offering great protection in rough terrain.

- Made of abrasion-resistant thermoformed High Molecular Weight Polyethylene (HMWPE).
- Lighter than aluminum.
- Superior stress crack resistance.
- High impact strength.
- Ultra-sturdy 3/8" (10 mm) thickness.

Offer your Maverick the full protection kit or get parts individually	MAVERICK SPORT & MAVERICK SPORT MAX				MAVERICK TRAIL	
	2019 BASE & DPS	2019 X mr	2020 & UP BASE & DPS	2020 & UP X mr	ANY YEAR X rc	
HMWPE SKID PLATE PROTECTION KIT						
• Includes: - HMWPE Front Skid Plate. - HMWPE Front A-Arm Protectors. - HMWPE Rear Skid Plate. - HMWPE Rear A-Arm Protectors. - HMWPE Underbelly Plates. - HMWPE Central Skid Plate.	715006348 (Except MAX)	715006353	715006349 (Except MAX)	715006350		715006346 (2019 & prior)
	715006352 (MAX Only)		715006351 (MAX Only)			715006347 (2020)
INDIVIDUAL HMWPE SKID PLATES						
① HMWPE Front Skid Plate	715008279	715008279	715008279	715008279	(Standard on X rc models)	715008279
② HMWPE Front A-Arm Protectors	715008276	715008277	715008276	715008277	(Standard on X rc models)	715008278
③ HMWPE Underbelly Plates <i>Keeps the rollover clearance.</i>	715006339	715006339	715006339	715006339		715006339 (2019 & prior)
					715006273 (2020)	715006273 (2020)
④ HMWPE Rear Skid Plate	715007302	715007302	715007302	715007302		715007302
⑤ HMWPE Rear A-Arm Protectors	715004271	715006341	715004271	715006341	(Standard on X rc models)	715003699
⑥ HMWPE Central Skid Plate <i>Provides center protection for MAX models.</i>	715004272 (MAX Only)		715004272 (MAX Only)			

BUMPERS & GUARDS

COMMANDER BUMPERS

Front Bumper	Commander, Commander MAX	715007631
---------------------	--------------------------	------------------



- Made of 1.5" (3.8 cm) diameter steel tubing with durable powder-coat finish.
- Includes integrated mount points for seamless light installation.
- Compatible with synthetic and steel rope winches and hawse fairlead.
- Not EC compliant.

Front Corner Protectors	Commander, Commander MAX	715006807
--------------------------------	--------------------------	------------------



- Heavy duty 1.5" (3.8 cm) diameter steel tubing.
- Inside and outside anti-corrosion coating with durable powder-coat finish.
- Provide additional protection for vehicle's front corners.
- Require Stock XT or XT-P bumper.
- Sold in pairs.

Rear Bumpers	Commander, Commander MAX	715006808
---------------------	--------------------------	------------------



- Rear bumper made of heavy-duty 1.5" (3.8 cm) diameter steel tubing.
- Protect vehicle bodywork and exhaust system.
- Inside and outside anti-corrosion coating with durable powder-coat finish.
- Compatible with Mud Flaps.
- Not EC compliant.

MAVERICK TRAIL & MAVERICK SPORT BUMPERS

Front Trail Bumper	Maverick Trail, Maverick Sport, Maverick Sport MAX	<ul style="list-style-type: none"> ■ 715003680 • Black ■ 715003681 • Sunburst Yellow
---------------------------	--	--



- Front bumper made of heavy-duty 1.5" (3.8 cm) diameter steel tubing.
- Completes the stock bumper for more front coverage and essential vehicle protection for trail riders.
- Inside and outside anti-corrosion coating with durable powder coat finish.
- Includes integrated mount points for seamless light installation.

Rear Trail Bumper	Maverick Trail, Maverick Sport, Maverick Sport MAX	<ul style="list-style-type: none"> ■ 715007109 • Black ■ 715003684 • Sunburst Yellow
--------------------------	--	--



- Rear bumper made of heavy-duty 1.5" (3.8 cm) diameter steel tubing.
- Protects vehicle bodywork and exhaust system.
- Inside and outside anti-corrosion coating with durable powder coat finish.
- Black version compatible with T-category models. Requires Licence Plate Holder (715007006) for installation on T-category models.
- Yellow version not compatible with T-category models.

Front Corner Protectors	Maverick Trail, Maverick Sport, Maverick Sport MAX	<ul style="list-style-type: none"> ■ 715004912 • Black ■ 715005230 • Sunburst Yellow
--------------------------------	--	--



- Heavy-duty 1.5" (3.8 cm) diameter steel tubing.
- Inside and outside anti-corrosion coating with durable powder coat finish.
- Provide additional protection for vehicle's front corners.
- Require Front Trail Bumper (715003680 / 715003681) for installation.
- Sold in pairs.

Rancher Front Bumper	Maverick Trail, Maverick Sport, Maverick Sport MAX	715004303
-----------------------------	--	------------------



- Heavy-duty protection made of 1.5" (3.8 cm) diameter steel tubing, perfect for farm, ranch and forestry applications.
- Inside and outside anti-corrosion coating with durable powder coat finish.
- Offers full front coverage and superior headlight protection.
- Removable radiator protector to allow light installation.
- Rugged look.
- Not EC compliant.
- Not compliant with T-category models.

Rancher Rear Bumper	Maverick Trail, Maverick Sport, Maverick Sport MAX	715004304
----------------------------	--	------------------



- Heavy-duty protection made of 1.5" (3.8 cm) diameter steel tubing, perfect for farm, ranch and forestry applications.
- Inside and outside anti-corrosion coating with durable powder coat finish.
- Offers full rear coverage with integrated tail light protectors.
- Not EC compliant.
- Not compliant with T-category models.

Lonestar Racing Front Bumper	Maverick Trail, Maverick Sport, Maverick Sport MAX	<ul style="list-style-type: none"> ■ 715005131 • Black ■ 715004871 • Can-Am Red
-------------------------------------	--	---



- Race-engineered to Lonestar Racing's trademark standards for toughness, these stylishly crafted accessories will also enhance your vehicle with visual impact.
- Made of 1.5" (3.8 cm) diameter steel tubing with durable powder coat finish.
- Billet End Cap with Lonestar Racing logo.
- Compatible with synthetic rope winches and Hawse Fairlead.

Lonestar Racing Rear Bumper	Maverick Trail, Maverick Sport, Maverick Sport MAX	<ul style="list-style-type: none"> ■ 715005133 • Black ■ 715004873 • Can-Am Red
------------------------------------	--	---



- Race-engineered to Lonestar Racing's trademark standards for toughness, these stylishly crafted accessories will also enhance your vehicle with visual impact.
- Made of 1.5" (3.8 cm) diameter steel tubing with durable powder coat finish.
- Billet End Cap with Lonestar Racing logo.
- Provides additional vehicle-rear bodywork and exhaust system protection in extreme driving conditions.

Lonestar Racing Number Plate	Maverick Trail, Maverick Sport, Maverick Sport MAX	715004878
-------------------------------------	--	------------------



- Race-bred in the Lonestar tradition of competition-level riding, this number plate will brand your vehicle a winner.
- Includes a pair of sturdy aluminum number plates.
- Create your personalized number decal through SCS Unlimited.
- Not compatible with the All-Terrain Trunk Cover.

DragonFire Front Bumper	Maverick Trail, Maverick Sport, Maverick Sport MAX	<ul style="list-style-type: none"> ■ 715005128 • Black ■ 715004456 • Can-Am Red
--------------------------------	--	---



- 1.5" (3.8 cm) diameter steel tubing with durable powder coat finish and reinforced with a 0.09" (2.3 mm) thick steel plate.
- Delivers additional protection for your vehicle.
- Sleek lines designed to match your vehicle's body and greatly enhance the overall look.
- Combines perfectly with the DragonFire Front Exo-Frame.
- Billet End Caps with DragonFire Logo.
- Not compatible with the Front Receiver Hitch.
- Includes brackets for auxiliary light mounting.

DragonFire Rear Bumper	Maverick Trail, Maverick Sport, Maverick Sport MAX	<ul style="list-style-type: none"> ■ 715005129 • Black ■ 715004457 • Can-Am Red
-------------------------------	--	---



- 1.5" (3.8 cm) diameter steel tubing with durable powder coat finish and reinforced with a 0.09" (2.3 mm) thick steel plate.
- Delivers additional protection for your vehicle.
- Sleek lines designed to match your vehicle's body and greatly enhance the overall look.
- Billet End Caps with DragonFire Logo.

DragonFire Front Exo-Frame	Maverick Trail, Maverick Sport, Maverick Sport MAX	<ul style="list-style-type: none"> ■ 715005127 • Black ■ 715004801 • Can-Am Red
-----------------------------------	--	---



- 1.5" (3.8 cm) diameter steel tubing with durable powder coat finish.
- Provides full front-corner and side-body protection.
- Sleek lines designed to match your vehicle's body and greatly enhance the overall look.
- DragonFire Front Bumper (715004456 / 715005128) is required for installation.
- Sold in pairs.

MAVERICK TRAIL & SPORT BUMPERS

S3⁺ Front Bumper	Maverick Trail, Maverick Sport, Maverick Sport MAX	<ul style="list-style-type: none"> ■ 715005121 • Black ■ 715004880 • Sunburst Yellow
------------------------------------	--	--



- Made of extra durable 1.5" (3.8 cm) diameter steel tubing.
- Inside and outside anti-corrosion coating with durable powder coat finish.
- Replaces stock bumper and adds superior protection for mud-riding enthusiasts.
- Integrated mount points for lights.
- Hook support anchor allows you to keep the winch hook within easy reach when riding in deep mud.
- "S3 for Can-Am" branded.
- Winch not included.

S3⁺ Rear Bumper	Maverick Trail, Maverick Sport, Maverick Sport MAX	<ul style="list-style-type: none"> ■ 715005122 • Black ■ 715004881 • Sunburst Yellow
-----------------------------------	--	--



- Made of extra durable 1.5" (3.8 cm) diameter steel.
- Inside and outside anti-corrosion coating with durable powder coat finish.
- Added heavy-duty protection in extreme driving conditions – protects vehicle bodywork and exhaust system.
- Permits installation of a winch at a higher location to improve accessibility in mud-riding conditions.
- Engineered to sustain heavy winch loads without damaging the vehicle's frame.
- Compatible with Can-Am HD and WARN VRX winches – Rear Winch Harness 715006008 is required to install a winch on the bumper.
- Includes a License Plate Support Mount.
- Not EC compliant.
- "S3 for Can-Am" branded.
- Winch not included.

Rear Winch Harness <i>(Not illustrated)</i>	Maverick Trail, Maverick Sport, Maverick Sport MAX	715006008
---	--	------------------

ROCK SLIDERS

Rock Sliders	Commander, Maverick Trail, Maverick Sport (Except X rc)	<ul style="list-style-type: none"> ■ 715003689 • Black ■ 715005228 • Sunburst Yellow
	Commander MAX, Maverick Sport MAX	■ 715004754 • Black



- Made of heavy-duty 1.5" (3.8 cm) diameter steel tubing.
- Inside and outside anti-corrosion coating with durable powder coat finish.
- Protect vehicle's rocker panels and undercarriage against large obstacles.
- Sold in pairs.

DragonFire Rock Sliders	Commander, Maverick Trail, Maverick Sport (Except X rc)	<ul style="list-style-type: none"> ■ 715003690 • Can-Am Red ■ 715005130 • Black
	Commander MAX, Maverick Sport MAX	■ 715005160 • Black



- 1.25" (3.2 cm) diameter steel tubing with durable powder coat finish.
- Sleek lines designed to match your vehicle's body and greatly enhance the overall look.
- Protect vehicle's undercarriage with minimal effect on ground clearance.
- 0.09 in. (2.3 mm) steel plate wraps the lower side of the vehicle for additional lateral protection.
- Sold in pairs.

Lonestar Racing Rock Sliders	Commander, Maverick Trail, Maverick Sport (Except X rc)	<ul style="list-style-type: none"> ■ 715005135 • Black ■ 715004875 • Can-Am Red
	Commander MAX, Maverick Sport MAX	■ 715004893 • Can-Am Red



- Race-engineered to Lonestar Racing's trademark standards for toughness, these stylishly crafted accessories will also enhance your vehicle with visual impact.
- Made of 1.5" (3.8 cm) diameter steel tubing with durable powder coat finish filled with 1/8" (3 mm) aluminum plate.
- Billet end-cap with Lonestar Racing logo.
- Protect vehicle sides from large obstacles.
- Sold in pairs.

INTRUSION BARS

Front Intrusion Bar	Commander, Commander MAX, Maverick Trail, Maverick Sport, Maverick Sport MAX	715003872
----------------------------	--	------------------



- Steel intrusion bar matches perfectly with vehicle's styling.
- Inside and outside anti-corrosion coating with durable powder coat finish.
- Provides additional protection by preventing large objects from entering the driver/passenger area.
- Tube design reduces obstructed lines of sight and blind spots for better visibility.
- Not compatible with windshields and Soft Door Panels.

DragonFire Front Intrusion Bar	Maverick Trail, Maverick Sport, Maverick Sport MAX (2020 and prior)	■ 715004455 • Can-Am Red
---------------------------------------	---	---------------------------------



- 1.25" (3.2 cm) diameter steel tubing with durable powder coat finish.
- Provides additional protection for driver and passenger.
- Unique design with a centered upper portion to minimize effects on visibility.
- Sleek lines designed to match your vehicle's body and greatly enhance the overall look.
- Not compatible with Bimini and Sport Roofs and full windshields.

DragonFire Spare Tire Holder	Maverick Trail, Maverick Sport, Maverick Sport MAX (Except X mr models)	<ul style="list-style-type: none"> ■ 715005125 • Black ■ 715004443 • Can-Am Red
-------------------------------------	---	---



- 1.5" (3.8 cm) diameter steel tubing with durable powder coat finish.
- Sleek lines designed to match your vehicle's body and greatly enhance the overall look.
- Easy-to-install roll cage mounted spare-tire holder.
- Accommodates tires up to 28" in diameter (wheel not included).
- Uses standard bolt pattern for wheel installation.
- Not compatible with LinQ pivoting rack, All-Terrain Trunk Cover, Gear Rail and accessories mounted in the cargo bed.

Lonestar Racing Front Intrusion Bar	Maverick Trail, Maverick Sport, Maverick Sport MAX (2020 and prior)	<ul style="list-style-type: none"> ■ 715005132 • Black ■ 715004872 • Can-Am Red
--	---	---



- Race-engineered to Lonestar Racing's trademark standards for toughness, these stylishly crafted accessories will also enhance your vehicle with visual impact.
- Made of 1.5" (3.8 cm) diameter steel tubing with durable powder coat finish.
- Provides additional protection for driver and passenger.
- Compatible with Lonestar Racing Aluminum Roof.
- Not compatible with windshields, Bimini Roof with Sun Visor and Sport Roof.

Lonestar Racing Rear Intrusion Bar	Maverick Trail, Maverick Sport Not compatible with S&B particle separator.	<ul style="list-style-type: none"> ■ 715005134 • Black ■ 715004874 • Can-Am Red
	Maverick Trail, Maverick Sport Compatible with S&B particle separator (Not illustrated).	<ul style="list-style-type: none"> ■ 715005413 • Black ■ 715005414 • Can-Am Red
	Maverick Sport MAX	<ul style="list-style-type: none"> ■ 715005420 • Black ■ 715005421 • Can-Am Red



- Race-engineered to Lonestar Racing's trademark standards for toughness, these stylishly crafted accessories will also enhance your vehicle with visual impact.
- Made of 1.5" (3.8 cm) diameter steel tubing with durable powder coat finish.
- Provides additional protection for driver and passenger.
- Not compatible with the Sport Roof, rear panels and windows, All-Terrain Trunk Cover.
- Not compatible with X mr models or with the Snorkel kit.

Lonestar Racing Spare Tire Holder	Maverick Trail, Maverick Sport, Maverick Sport MAX (Except X mr)	<ul style="list-style-type: none"> ■ 715005136 • Black ■ 715004876 • Can-Am Red
--	--	---



- Race-conceived for riders who believe a Plan B means thinking like a pro.
- Holds wheel securely no matter how rough the trail.
- Made of 1.5" (3.8 cm) diameter steel tubing with durable powder coat finish.
- Easy, bolt-on installation on roll cage.
- Can accommodate tires up to 27" (wheel not included).
- Not compatible with All-Terrain Trunk Cover, Fixed Tailgate, LinQ Cargo Rack and LinQ Rack Extension.
- Not compatible with Snorkel kit.

FENDER FLARES

Fender Flares	Commander, Commander MAX	715006814
----------------------	--------------------------	------------------



- Fender flares made from injection-molded polypropylene.
- Keep mud and debris out of vehicle.
- Designed for quick and easy installation.
- Front and rear extensions and mounting hardware included.
- Increase vehicle's overall width by 3" (8 cm) when installed on Commander and Commander MAX models.

2" (51 mm) Fender Flares	Maverick Trail	715004958
---------------------------------	----------------	------------------



- Extended fender flares made from injection-molded polypropylene.
- Keep mud and debris out of vehicle.
- Designed for quick and easy installation.
- Include front and rear extensions, mounting hardware and Fender Flare Rear Extensions (715004404).
- Increase vehicle's overall width by 3.5" (8.9 cm).

Fender Flare Rear Extensions	Maverick Trail	715004404
-------------------------------------	----------------	------------------

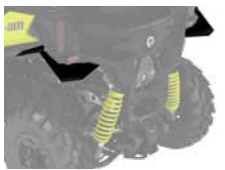

- Help tail light stay clean from debris and mud to remain visible. Can be installed with 2" (51 mm) Fender Flares (715003625).
- Made from injection-molded polypropylene for best fit and finish.
- Sold in pairs.
- Included with the 2" (51 mm) Fender Flares (715004958) and with the Fender Flare Extensions (715004462).

3" (76 mm) Fender Flares	Maverick Trail, Maverick Sport, Maverick Sport Max	715004959
---------------------------------	--	------------------



- Fender flares made from injection-molded polypropylene.
- Keep mud and debris out of vehicle.
- Designed for quick and easy installation.
- Include front and rear extensions and mounting hardware.
- Increase vehicle's overall width by 6" (15.3 cm) when installed on Maverick Trail models.
- Standard on Maverick Sport models.

Fender Flare Rear Extensions	Maverick Trail, Maverick Sport, Maverick Sport MAX	715004462
-------------------------------------	--	------------------



- Block terrain debris from kicking up onto you as you ride or damaging your vehicle thanks to these extra-large Fender Flare Extensions, which also include rear extensions (715004404) for added protection from mud/snow, especially when riding with track kits.
- Made from injection-molded polypropylene for best fit and finish.
- Not compatible with 2" (51 mm) Fender Flares.
- Include front and rear extensions.
- For Maverick Trail, must be used with 3" (76 mm) Fender Flares (715004959).
- Standard on Maverick Sport X mr models.

OTHERS

License Plate Holder	Maverick Trail, Maverick Sport, Maverick Sport MAX	715007006
-----------------------------	--	------------------



- Supports your license plate on the Rear Trail Bumper.
- Plate lights can be relocated on bumper to light up license plate.
- Require Rear Trail Bumper (715007109) for installation.
- EC compliant.

Tail Light Protectors	Maverick Trail, Maverick Sport, Maverick Sport MAX	715003692
------------------------------	--	------------------



- Anti-corrosion coating with durable powder coat finish.
- Rugged style, aggressive look.
- Sold in pairs.
- Not EC compliant.

Radiator Protector	Maverick Trail, Maverick Sport, Maverick Sport MAX	715003700
---------------------------	--	------------------

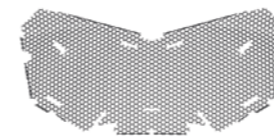

- Perforated steel shield mounted over the radiator face, providing protection from stones and branches.
- Not recommended for winter use.

SEAT ACCESSORIES

4-Point Harness	Commander, Commander MAX, Maverick Trail, Maverick Sport, Maverick Sport MAX	715008035 • Driver 715008036 • Passenger
------------------------	--	---



- Exclusive controlled decelerator technology (patent pending) absorbs additional energy in case of accident.
- Designed to offer maximum riding comfort.
- Easy one-click latch and release.
- Not EC compliant.
- ROHVA compliant.
- Requires 4-point harness bar, ROHVA compliant when used in conjunction with Can-Am harness bars.

4-Point Harness Bar	Commander MAX, Maverick Sport MAX	715004847
----------------------------	-----------------------------------	------------------



- 1.5" (3.8 cm) diameter, thick-walled steel tubing.
- Designed for use with Can-Am 4-Point Harness.
- Not EC compliant.

Seat Belt Shoulder Pads	Commander, Commander MAX, Maverick Trail, Maverick Sport, Maverick Sport MAX	715002894
--------------------------------	--	------------------



- Provide additional riding comfort by preventing seat belt from rubbing on neck and shoulder.
- Fit with stock 3-point seat belts and 4 point harness.
- Easy Velcro installation.
- Can-Am branded.
- Sold in pairs for driver and passenger.

LinQ: EASY ON, EASY OFF CARGO

COMMANDER'S LinQ ACCESSORIES

- No tools needed: Quickly install and remove accessories by hand.
- Equip your Can-Am for specialized tasks in no time.
- Sturdy mounting system that holds up to the roughest terrain.

MOUNTING LOCATION AND REQUIREMENTS

Vehicle Standard Cargo Box	LinQ Cargo Rack 715006815	Adventure Roof Rack 715004095	Deluxe Headache Rack 715006823	Rear Adventure Rack 715006809	Passenger Seat Base
----------------------------	------------------------------	----------------------------------	-----------------------------------	----------------------------------	---------------------

LinQ ACCESSORIES WITH 16" BASE

- LinQ anchors mounted 16 inches apart, center-to-center.
- Lower loading capacity than the LinQ with 36" base accessories.
- Can be used on Can-Am ATV and SSV vehicles, Can-Am Spyder and Ryker vehicles, Sea-Doo watercraft and Ski-Doo snowmobiles.

LinQ 4.2 gal Cooler 295100698 • Grey 219400964 • Black	LinQ Base Installation Kit 715008125	LinQ Base Installation Kit 715008125	LinQ Base Installation Kit 715008125			
LinQ Tool Kit 715006829	No further requirements	No further requirements	No further requirements			
LinQ Tool Box 715008111						
LinQ SR 5.5 gal (21 L) Bag 860202449	LinQ Base Installation Kit 715008125	LinQ Base Installation Kit 715008125	LinQ Base Installation Kit 715008125	LinQ Base Installation Kit 715008125	LinQ Base Installation Kit 715008125	Passenger Seat LinQ Anchor Kit 715003951
LinQ 4.5 gal (17 L) Sport Bag 860202447						
LinQ Modular Box 715005494 • (10 L) 715007112 • (20 L) 715006830 • (30 L)	No further requirements	No further requirements	No further requirements			
LinQ Dry Bag 715008110	LinQ Base Installation Kit 715008125	LinQ Base Installation Kit 715008125	LinQ Base Installation Kit 715008125			

LinQ ACCESSORIES WITH 36" BASE

- Mount on LinQ racks often used by Can-Am ORV vehicles.
- Higher loading capacity than the LinQ with 16" base accessories.
- Usage is limited to Can-Am ORV vehicles.

LinQ 12 gal (45 L) Cargo Box 715003879						
LinQ 23 gal (86 L) Trunk Box 715004923						
LinQ Audio Box 715003018						
LinQ Cooler 715004778 • Black 715004698 • Grey	No Compatibility	No further requirements	No Compatibility	No Compatibility	No Compatibility	No Compatibility
LinQ OGIO[®] Bag 715002923 • Black 715004698 • Grey						
LinQ Heavy Duty Basket 715001215						
LinQ Low Profile Basket 715004282						

LinQ HOLDERS

LinQ Gear Grips 715005340	No further requirements	No further requirements	Side wall installation LinQ Adaptors 715003058	Side wall installation LinQ Adaptors 715003058	Side wall installation LinQ Adaptors 715003058	Passenger Seat LinQ Anchor Kit 715003951
LinQ Tool Holder 715007358	No further requirements	No further requirements				

MAVERICK'S LinQ ACCESSORIES

- No tools needed: Quickly install and remove accessories by hand.
- Equip your Can-Am for specialized tasks in no time.
- Sturdy mounting system that holds up to the roughest terrain.

MOUNTING LOCATION AND REQUIREMENTS

Vehicle Standard Cargo Box	LinQ Cargo Rack 715003702	Adventure Roof Rack 715004095	LinQ Pivoting Rack 715008297	All-Terrain Trunk Cover 715003701	Passenger Seat Base
----------------------------	------------------------------	----------------------------------	---------------------------------	--------------------------------------	---------------------

LinQ ACCESSORIES WITH 16" BASE

- LinQ anchors mounted 16 inches apart, center-to-center.
- Lower loading capacity than the LinQ with 36" base accessories.
- Can be used on Can-Am ATV and SSV vehicles, Can-Am Spyder and Ryker vehicles, Sea-Doo watercraft and Ski-Doo snowmobiles.

LinQ 4.2 gal Cooler 295100698 • Grey 219400964 • Black	LinQ Base Installation Kit 715008125	No Compatibility	LinQ Base Installation Kit 715008125	LinQ Anchor Adaptor Kit 715004960	LinQ Base Installation Kit 715008125	Passenger Seat LinQ Anchor Kit 715003951
LinQ Tool Kit 715006829	No further requirements	No further requirements	No further requirements	No further requirements	No further requirements	No further requirements
LinQ Tool Box 715008111						
LinQ SR 5.5 gal (21 L) Bag 860202449	LinQ Base Installation Kit 715008125	No Compatibility	LinQ Base Installation Kit 715008125	LinQ Anchor Adaptor Kit 715004960	LinQ Base Installation Kit 715008125	Passenger Seat LinQ Anchor Kit 715003951
LinQ 4.5 gal (17 L) Sport Bag 860202447						
LinQ Modular Box 715005494 • (10 L) 715007112 • (20 L) 715006830 • (30 L)	No further requirements	No further requirements	No further requirements	No further requirements	No further requirements	No further requirements
LinQ Dry Bag 715008110	LinQ Base Installation Kit 715008125	No Compatibility	LinQ Base Installation Kit 715008125	LinQ Anchor Adaptor Kit 715004960	LinQ Base Installation Kit 715008125	Passenger Seat LinQ Anchor Kit 715003951

LinQ ACCESSORIES WITH 36" BASE

- Mount on LinQ racks often used by Can-Am ORV vehicles.
- Higher loading capacity than the LinQ with 16" base accessories.
- Usage is limited to Can-Am ORV vehicles.

LinQ 12 gal (45 L) Cargo Box 715003879		No further requirements				
LinQ 23 gal (86 L) Trunk Box 715004923		No further requirements				
LinQ 32 gal (121 L) Trunk Box 715001747		No Compatibility				
LinQ Audio Box 715003018		No further requirements				
LinQ Cooler 715004778 • Black 715004698 • Grey	No Compatibility	No Compatibility	No Compatibility	No further requirements	No Compatibility	No Compatibility
LinQ OGIO Bag 715002923 • Black 715003248 • Camo						
LinQ Heavy Duty Basket 715001215		No further requirements				
LinQ Low Profile Basket 715004282						

LinQ HOLDERS

LinQ Gear Grips 715005340	No further requirements (When installed on side walls)	No Compatibility	Side wall installation LinQ Adaptors 715003058	No further requirements	LinQ Base Installation Kit 715008125	No further requirements
LinQ Tool Holder 715007358						

LinQ ACCESSORIES WITH 16" BASE

LinQ Modular Box	Commander, Commander MAX Maverick Trail, Maverick Sport, Maverick Sport MAX	715005494 • (10 L)
		715007112 • (20 L)
		715006830 • (30 L)



- Allows stacking of other modular boxes to always have the right gear accessible.
- Always have the right box size to fit everything.
- Can be installed on any LinQ base with a 16" width.
- See table for installation location and requirements.

Thermal Insert for LinQ Modular Box (10 L)	Commander, Commander MAX Maverick Trail, Maverick Sport, Maverick Sport MAX	219401110
---	---	------------------



- Insulated liner.
- Fits very well in the LinQ Modular Box (10 L).
- Can contain five 473 ml cans or six 355 ml cans.

LinQ Tool Box	Commander, Commander MAX Maverick Trail, Maverick Sport, Maverick Sport MAX	715008111
----------------------	---	------------------



- High precision injected HDPE construction provides rigidity and durability.
- 5 gal (19 L) maximum capacity.
- Weather-resistant, sealed and lockable cover.
- Easy one-second on/off tool-less system.
- All the benefits of LinQ—simple, fast and secure.
- See table for installation location and requirements.

LinQ Tool Kit	Commander, Commander MAX Maverick Trail, Maverick Sport, Maverick Sport MAX	715006829
----------------------	---	------------------



- Includes:
 - Cutter pliers.
 - Long-nose pliers.
 - Locking pliers.
 - Ratchet wrench 3/8" drive.
 - 6" ratchet extension.
 - Integrated CVT belt storage location (belt not included).
 - Long-socket 19 mm 3/8" drive - 6pts.
 - Socket 18 mm 3/8" drive.
 - Long-socket 17 mm 3/8" drive - 6pts.
 - Socket 15 mm 3/8" drive.
 - Socket 13 mm 3/8" drive.
 - Socket 10 mm 3/8" drive.
 - Socket 8 mm 3/8" drive.
 - Combined wrench 19 mm.
 - Combined wrench 18 mm.
 - Combined wrench 15 mm.
 - Combined wrench 13 mm.
 - Combined wrench 10 mm.
 - Combined wrench 8 mm.
 - Socket torx T30 3/8" drive.
 - Socket torx T20 3/8" drive.
 - Breaker bar 3/8" drive.
 - See table for installation location and requirements.
 - Socket torx T40 3/8" drive.

LinQ 4.2 Gal (16 L) Cooler	Commander, Commander MAX Maverick Trail, Maverick Sport, Maverick Sport MAX	<ul style="list-style-type: none"> ■ 219400964 • Black ■ 295100698 • Grey
-----------------------------------	---	---



- All the benefits of LinQ—simple, fast and secure.
- Rotomolded construction for exceptional rigidity and durability.
- Premium-quality foam insulation for optimal ice retention.
- Uses LinQ mounting system (Patent US 8777531 and US 8875830).
- Easy one-second on/off tool-less system.
- See table for installation location and requirements.

LinQ 4.5 Gal (17 L) Sport Bag	Commander, Commander MAX Maverick Trail, Maverick Sport, Maverick Sport MAX	860202447
--------------------------------------	---	------------------



- 17-liter (4.5 US gallon, 1,037 cu. in.) capacity.
- Rigid bottom, semi-rigid top.
- See table for installation location and requirements.

SR 5.5 Gal (21 L) LinQ Bag	Commander, Commander MAX Maverick Trail, Maverick Sport, Maverick Sport MAX	860202449
-----------------------------------	---	------------------



- All the benefits of LinQ - simple, fast and secure.
- Semi-rigid expandable bag.
- 5.5 gal (21L) capacity.
- Utilizes LinQ mounting system (Patent US 8777531 and US 8875830).
- Easy one-second on/off tool-less system.
- Requires LinQ Base Installation Kit.
- Maverick Trail, Maverick Sport, Maverick Sport MAX: LinQ Base Installation Kit required for rear cargo installation or Passenger Seat Base LinQ Kit required for passenger seat installation.

LinQ Dry Bag	Commander, Commander MAX Maverick Trail, Maverick Sport, Maverick Sport MAX	715008110
---------------------	---	------------------



- Fully waterproof roll-top dry bag will securely store and confine your equipment.
- LinQ mounted using heavy-duty rigid plastic base.
- High capacity storage solution (40 L).
- Bottom foam liner for additional equipment protection.
- Integrated handle for easy transportation on/off the vehicle.
- See table for installation location and requirements.

LinQ ACCESSORIES WITH 36" BASE

LinQ Premium Storage Bag by OGIO	Commander, Commander MAX Maverick Trail, Maverick Sport, Maverick Sport MAX	<ul style="list-style-type: none"> ■ 715002923 • Black ■ 715003248 • Camo
---	---	---



- Tool-less installation and removal thanks to the LinQ system.
- 17.2 gal (65 L) capacity semi-rigid cargo bag ideal for carrying anything you need on your vehicle.
- Buckle and elastic closure with a rubber seal that protects dust from entering the bag.
- 3-section lid for partial or full access to your bag.
- Inside separators for optimal bag organization.
- See table for installation location and requirements.

LinQ 12 Gal (45 L) Cargo Box	Commander, Commander MAX Maverick Trail, Maverick Sport, Maverick Sport MAX	715003879
-------------------------------------	---	------------------



- LinQ mounted for easy-on, easy-off installation.
- Holds cargo safely and securely while riding.
- See table for installation location and requirements.

LinQ 23 Gal (86 L) Trunk Box	Commander, Commander MAX Maverick Trail, Maverick Sport, Maverick Sport MAX	715004923
-------------------------------------	---	------------------



- LinQ mounted for easy-on, easy-off installation.
- Holds cargo safely and securely while riding.
- See table for installation location and requirements.

LinQ 11.5 Gal (43 L) Audio Cargo Box	Commander, Commander MAX Maverick Trail, Maverick Sport, Maverick Sport MAX	715003018
---	---	------------------



- An affordable and quick solution for adding music and storage to your next ride.
- The rear installation does not use up any cab space and allows easy listening at an average speed.
- Mounts on/off easily to hold/carry cargo safely and securely.
- Backlit control panel perfect for night riding.
- Water-resistant speakers.
- The Bluetooth¹ enabled receiver and 6.5" (16.5 cm) speakers are smartly concealed and integrated in the cover.
- Automatic shut-off function protects your battery by turning the system off after 10 minutes of inactivity.
- See table for installation location and requirements.

LinQ ACCESSORIES WITH 36" BASE

<p>LinQ 8 Gal (30 L) Cooler Box</p> 	<p>Commander, Commander MAX Maverick Trail, Maverick Sport, Maverick Sport MAX</p>	<p>■ 715004778 • Black ■ 715004698 • Grey</p> <ul style="list-style-type: none"> • LinQ mounted for easy-on, easy-off installation. • Rotomolded construction provides exceptional rigidity and durability. • Premium-quality foam insulation for optimal ice retention. • Integrated, fully removable compartment protects food. • Robust rubber latches keep the cover tightly closed. • Weather-resistant. • Convenient drain plug. • See table for installation location and requirements.
---	--	--

<p>LinQ 32 Gal (121 L) Trunk Box</p> 	<p>Maverick Trail, Maverick Sport, Maverick Sport MAX European Version (EC compliant)</p>	<p>715001747 • Black (Rear tail light included) 715001748 • (No rear tail light)</p> <ul style="list-style-type: none"> • Equipped with the LinQ System, the rear trunk box plugs in and out in seconds. • 32 gal (121 L) load capacity with unobstructed space to maximize storage room and access to the trunk's interior. • Made of injection-molded polyethylene, double walled in critical areas. • The fully sealed lid protects your belongings from dust, moisture and the elements. • Trunk Box Panels available in many colors to match your vehicle (sold separately). • See table for installation location and requirements.
---	---	---

<p>LinQ 32 Gal (121 L) Trunk Box Panels</p>	<p>Maverick Trail, Maverick Sport, Maverick Sport MAX</p> <ul style="list-style-type: none"> • Color panels to match the LinQ 32 gal (121 L) to your vehicle (715001747 / 715001748).
--	--

<p>■ 715001391 • Black ■ 715001392 • Yellow ■ 715001395 • Viper Red ■ 715002481 • White ■ 715002480 • Light Grey ■ 715002984 • Octane Blue</p>	<p>■ 715002985 • Manta Green ■ 715002986 • Can-Am Red ■ 715006119 • Orange Crush ■ 715006120 • Squadron Green ■ 715007074 • Tundra Green</p>	<p>European Version (EC compliant) No rear tail light ■ 715001397 • Black ■ 715001398 • Yellow ■ 715002482 • Light Grey</p>	<p>■ 715002483 • White ■ 715006121 • Can-Am Red ■ 715006122 • Manta Green ■ 715006123 • Orange Crush ■ 715006124 • Viper Red</p>
--	---	--	---

<p>LinQ Heavy-Duty Basket</p> 	<p>Commander, Commander MAX Maverick Trail, Maverick Sport, Maverick Sport MAX</p>	<p>715001215</p> <ul style="list-style-type: none"> • Made of high-strength, low-alloy steel. • LinQ mount for easy-on, easy-off installation. • See table for installation location and requirements.
--	--	--

<p>LinQ Low Profile Basket</p> 	<p>Commander, Commander MAX Maverick Trail, Maverick Sport, Maverick Sport MAX</p>	<p>715004282</p> <ul style="list-style-type: none"> • Low profile, open basket increases cargo space. • Perfect for easy access to tools, rope, winch and plow accessories. • Multiple bungee cord and tie-down anchor points. • Made of impact-resistant injected polypropylene. • See table for installation location and requirements.
---	--	---

LinQ HOLDERS

<p>LinQ Tool Holder</p> 	<p>Commander, Commander MAX Maverick Trail, Maverick Sport, Maverick Sport MAX</p>	<p>715007358</p> <ul style="list-style-type: none"> • Ultra-versatile tool holder. • Convenient swivel-latch allows tools to be stored in any orientation. • Sold in pairs. • See table for installation location and requirements.
--	--	--

<p>LinQ Gear Grips</p> 	<p>Commander, Commander MAX Maverick Trail, Maverick Sport, Maverick Sport MAX</p>	<p>715005340</p> <ul style="list-style-type: none"> • Durable and flexible grips provide a custom fit for a variety of items from 1" to 4" (2.5 cm to 10 cm) in diameter. • Heavy-duty design for carrying bows, fishing poles, rakes, farm tools and more. • Quick-release button opens grip quickly for easy access to gear. • Heavy-duty base system built for the toughest adventures. • Make transporting your tools a snap by combining the Gear Grips with the LinQ System. • 360° orientation. • Sold in pairs.
---	--	---

LinQ ACCESSORIES

<p>LinQ Adaptor <i>(Not illustrated)</i></p>	<p>Commander, Commander MAX Maverick Trail, Maverick Sport, Maverick Sport MAX</p>	<p>715003058</p> <ul style="list-style-type: none"> • Sold in pack of 4.
---	--	--

<p>LinQ Base Installation Kit</p> 	<p>Commander, Commander MAX Maverick Trail, Maverick Sport, Maverick Sport MAX</p>	<p>715008125</p> <ul style="list-style-type: none"> • Unique mounting fastener usable on any LinQ System accessory. • Included: 2 Cargo LinQ bases and hardware.
--	--	---

<p>LinQ Lock</p> 	<p>Commander, Commander MAX Maverick Trail, Maverick Sport, Maverick Sport MAX</p>	<p>860201968</p> <ul style="list-style-type: none"> • Simple way to lock most LinQ accessories in place. • Retrofits most LinQ accessories. • A cover protects the lock from the elements. • Not compatible with Tool Holder or LinQ Gear Grips. • Pack of one. • Comes with two keys.
---	--	---

<p>LinQ Replacement Part</p> 	<p>Maverick Trail, Maverick Sport, Maverick Sport MAX</p>	<p>715001707</p> <ul style="list-style-type: none"> • Sold in pairs.
---	---	--

<p>LinQ Anchor Adaptor kit</p> 	<p>Maverick Trail, Maverick Sport, Maverick Sport MAX</p>	<p>715004960</p> <ul style="list-style-type: none"> • Allows the installation of LinQ accessories with 16" base on LinQ racks. • Tool-less installation and removal. • LinQ pivoting rack is required for installation.
---	---	---

<p>LinQ Passenger Seat Base Kit</p> 	<p>Commander, Commander MAX Maverick Trail, Maverick Sport, Maverick Sport MAX</p>	<p>715003951</p> <ul style="list-style-type: none"> • LinQ base kit that installs on the passenger seat frame underneath the bottom seat cushion. • Allows installation of compatible LinQ accessories inside the cabin. • Passenger seat cushion can be reinstalled over the LinQ base kit when not in use.
--	--	--

CARGO & STORAGE

CARGO

<p>LinQ Cargo Rack</p> 	<p>Commander, Commander MAX</p>	<p>715006815</p> <ul style="list-style-type: none"> • Strong, durable steel rack 3/8". • Easy and tool-less installation with LinQ system. • Allows the installation of LinQ accessories. • Allows multi-level storage on cargo bed. • Helps keep cargo securely in place. • Multiple bungee cord and tie-down points. • Kit includes LinQ Base 36". • 15" clearance under the rack for other cargo. • Not compatible with 715006816 and 715006819.
---	---------------------------------	---

<p>Integrated Tailgate Extension</p> 	<p>Commander, Commander MAX</p>	<p>715006810</p> <ul style="list-style-type: none"> • Integrated design that lets the extension fold away inside the tailgate when not needed. • Steel construction for rugged durability. • Not EC compliant.
---	---------------------------------	--

Tonneau Cover	Commander, Commander MAX	715006816
----------------------	--------------------------	------------------



- Fitted to cover all of the items in your cargo box.
- Prevents splash from entering the cargo box.
- Rolls up to the front.
- Easily removable for quick access.
- Not compatible with accessories that exceed the bed height.

All-Terrain Trunk Cover	Maverick Trail, Maverick Sport (Except X mr), Maverick Sport MAX	715003701
--------------------------------	--	------------------



- Transforms your rear cargo area into a fully enclosed and weather-resistant car-like trunk box.
- Gas spring assisted opening.
- Integrated mounting location inside the trunk cover for Dome Light (715002455) (sold separately).
- Rotomolded construction provides exceptional rigidity.
- LinQ accessories can be installed on or inside the trunk cover.
- LinQ Base Installation Kit required for installation on the trunk cover.

Fixed Tailgate	Maverick Trail, Maverick Sport, Maverick Sport MAX	715004357
-----------------------	--	------------------



- Rigid rotomolded construction.
- Encloses perfectly the rear cargo opening and helps cargo securely in place.
- Matches the vehicle's styling.

STORAGE

Storage 2.6 Gal (10 L) Bag	Commander, Commander MAX, Maverick Trail, Maverick Sport, Maverick Sport MAX	269502121
-----------------------------------	--	------------------



- Roll-top dry bag for fully protecting your cargo from the elements.

Soft Storage Bag	Commander, Commander MAX, Maverick Trail, Maverick Sport, Maverick Sport MAX	715003759
-------------------------	--	------------------



- 11.8 gal (45 L) capacity soft cargo bag designed with vehicle's rear in mind to maximize potential storage.
- 3-section bag.
- Transport gear in a weatherproof bag.

Overhead Storage Bags	Commander, Commander MAX, Maverick Trail, Maverick Sport, Maverick Sport MAX	715005018
------------------------------	--	------------------



- Weather-resistant bags, hold your gear safely and securely while riding.
- Include 2 overhead soft bags mounted on a tubular frame that sits between cage and roof.
- 2.4 gal (9 L) total capacity.
- Bimini Roof with sun visor or Sport Roof needed for installation.
- Not compatible with the Complete Wet Sounds Audio System.

Shoulder Storage Bag	Commander, Commander MAX, Maverick Trail, Maverick Sport, Maverick Sport MAX	715005019
-----------------------------	--	------------------



- Weather-resistant semi-rigid bag holds your gear safely and securely while riding.
- Bag attaches in unused space between the seats to increase your vehicle's cargo capacity.
- 2.8 gal (10.5 L) capacity.

Removable Central Storage Bag	Commander, Commander MAX, Maverick Trail, Maverick Sport, Maverick Sport MAX	715004794
--------------------------------------	--	------------------



- Weather-resistant bag holds your gear safely and securely while riding.
- Both front and rear passengers can access the bag's content.
- Designed as a 1.3 gal (5.2 L) capacity pocket, also equipped with inner netting compartments and side pockets.
- Can be removed in seconds and includes shoulder strap for transportation.
- Perfect to bring your gear on and off your vehicle.

Soft Cooler	Commander, Commander MAX, Maverick Trail, Maverick Sport, Maverick Sport MAX	715003728
--------------------	--	------------------



- Soft cooler made of durable canvas.
- Removable shoulder strap and carry handles.
- Foam insulation and water-resistant interior liner.
- 2.2 gal (4.5 L) capacity.

RACKS

Adventure Roof Rack	Commander MAX, Maverick Sport MAX	715004095
----------------------------	-----------------------------------	------------------



- Ideal cargo solution for packing everything you need to live your off-road experience fully and completely.
- Built with heavy-duty 1.5" (3.8 cm) and 1.25" (3.2 cm) diameter steel tubing.
- Loads of up to 75 lb (34 kg).
- LinQ support plates allow for installation of accessories with 16" base.
- Integrated mounting points for the installation of the 39" (99 cm) Double Stacked LED Bar (front).
- Features anchor points for spare tire attachment.
- Spare Tire Tie-Downs sold separately.
- Add the Cargo Box Net to secure and confine your cargo in the rack.
- Can be installed without a roof or with Sport Roof only.

Rear Adventure Rack	Commander, Commander MAX	715006809
----------------------------	--------------------------	------------------



- Made of heavy-duty steel.
- Increases the cargo versatility of the vehicle.
- Allows a Commander 2-up to fit a MAX Sport Roof or Bimini Roof on top to protect the cargo area.
- Allows a Commander 2-up to fit max adventure roof rack to increase cargo capacity.
- Not compatible with other bed installed accessories.

NEW Adventure Rack Enclosure	Commander, Commander MAX	715006818 715008246
-------------------------------------	--------------------------	--------------------------------------



- Works with Rear Adventure Rack.
- Rear-panel zip-type windows with roll-down feature.
- Covers all accessories mounted inside of the Rear Adventure Rack.
- Compatible only with Sport Roof.

Cargo Bed Rails	Commander, Commander MAX	715006824
------------------------	--------------------------	------------------



- Add an integrated tie-down area to your cargo box.
- Added cargo box protection.
- Inside and outside anti-corrosion coating with durable powder-coat finish.
- Heavy-duty 1" (2.5 cm) diameter steel tube construction.
- Adds height to the bed side wall and serves as a tie-down point.
- Sold in pairs.

Deluxe Headache Rack	Commander, Commander MAX	715006823
-----------------------------	--------------------------	------------------



- Protects cab from cargo load.
- Compatible with cargo bed rails.

LinQ Pivoting Rack	Maverick Trail, Maverick Sport, Maverick Sport MAX	715008297
---------------------------	--	------------------



- LinQ latched rack allows for extra LinQ mounted accessories or the addition of ATV LinQ rack extensions.
- Includes custom tie-down strap for fast spare tire installation or removal (tire not included).
- Gas-cylinder pivot action, locks in the raised position.
- Not compatible with Gear Rail (715003703), Lonestar Racing and DragonFire tire carrier, Lonestar Racing Number Plate, Rear Intrusion Bars and LinQ Cargo Rack.
- Compatible with the All-Terrain Trunk Cover.

Front Rack	Maverick Trail, Maverick Sport, Maverick Sport MAX	715004302
-------------------	--	------------------



- Rugged looking front rack mounts on top of vehicle hood and provides additional protection and cargo capacity.
- Heavy-duty 3/4" (1.9 cm) diameter steel-tube construction.
- 50 lb (22.7 kg) load capacity.
- Inside and outside anti-corrosion coating with durable powder coat finish.
- Flip-up configuration provides easy access to service area.
- Not compatible with DragonFire Front Exo-Frame.

LinQ Rack Extension	Maverick Trail, Maverick Sport, Maverick Sport MAX	715003771
----------------------------	--	------------------



- Made of strong and durable die-cast aluminum.
- Helps to keep cargo securely in place.
- Easy and tool-less installation thanks to the LinQ System.

LinQ Cargo Rack	Maverick Trail, Maverick Sport, Maverick Sport MAX	715003702
------------------------	--	------------------



- Made of durable die-cast aluminum and strong aluminum tubing frame.
- Allows the installation of LinQ Trunk Boxes on top and the addition of more LinQ accessories in cargo box.
- Easy and tool-less installation thanks to the LinQ System.

Spare Tire Carrier	Maverick Trail, Maverick Sport, Maverick Sport MAX	715004471
---------------------------	--	------------------



- Holds spare tire in place.
- Designed for fast tire removal.
- Can hold tires up to 30" in diameter (tire is not included).
- Rear bumper mounted, does not encumber the cargo area.
- Made of heavy-duty 1.5" (3.8 cm) diameter steel tubing.
- Inside and outside anti-corrosion coating with durable powder coat finish.
- Requires Rear Trail Bumper (715007109) or Rear Rancher Bumper (715004304).

Cargo Box Net	Commander, Commander MAX, Maverick Sport MAX	715001371
----------------------	--	------------------



- Solid net designed to secure and ensure the compact confinement of your Adventure Roof Rack.

LinQ Tool and Gun Holder	Commander, Commander MAX	715005466
---------------------------------	--------------------------	------------------



- 2-in-1 holding rack can be used both on the job or on the hunt.
- Include 5 locations to securely hold tools and guns using rubber grips and retention straps at the top and a rubber mat with gunstock shaped molding at the bottom.
- Easy to remove, install or reposition using our simple and secure LinQ system.
- Can be attached at multiple positions along the cargo bed walls, facing inside or outside the bed.
- Can be attached on the inside of the cargo, behind the cab.
- Not compatible with Headache Rack.

LinQ Gun Boot	Commander, Commander MAX, Maverick Trail, Maverick Sport, Maverick Sport MAX	715004968
----------------------	--	------------------



- Practical design allows you to store shotguns and rifles up to 52" (132 cm) even with optics.
- Adapt to different weapon shapes and features with foam cushions that can be repositioned.
- LinQ-mounted for efficient and secure storage, locked in place with only a quarter turn.

Stronghold Gun Boot Impact¹ by Kolpin¹	Maverick Trail, Maverick Sport, Maverick Sport MAX	705011442
---	--	------------------



- Compact low-profile design with Kolpin Stronghold styling securely holds up to 52" (132 cm) long rifles and shotguns with optics.
- Includes a removable, shock absorbing foam Impact liner.
- Single-handed opening with an attached lid for quick access along with an integrated closure strap.
- For use with the Kolpin Stronghold Auto-Latch Mount System.

Stronghold Auto-Latch Mount by Kolpin	Maverick Trail, Maverick Sport, Maverick Sport MAX	715003899
--	--	------------------



- Auto-latching design provides quick and secure gun boot attachment to your vehicle.
- Bracket is made from rugged high-impact, reinforced nylon and coated steel.
- For use with Stronghold Gun Boot (705011442).
- Requires Gear Rail (715003703).

Gear Rail	Maverick Trail, Maverick Sport, Maverick Sport MAX	715003703
------------------	--	------------------



- Sturdy gear rail design with C-clamps attached on the roll cage.
- Offers mounting points for the Stronghold Auto-Latch Mount or for the Universal Saw Press by Kolpin.
- Can hold up to two gun boots.
- Not compatible with the Gun Boot 6.0 Impact by Kolpin (715001419).

Universal Saw Press by Kolpin	Maverick Trail, Maverick Sport, Maverick Sport MAX	715001423
--------------------------------------	--	------------------



- Specially crafted for transporting your chainsaw securely and safely aboard your side-by-side vehicle.
- Heavy-duty, black powder-coated metal bracket designed to attach any chainsaw model with up to a 20" (51 cm) bar.
- Rubber pads provide cushion and tight fit.
- Hinged design for quick removal.
- Holds saw in vertical position or 45° angle in either direction.
- Requires Gear Rail (715003703).
- Protective sheath included.

Spare Tire Ratchet Tie-Downs	Commander, Commander MAX, Maverick Trail, Maverick Sport, Maverick Sport MAX	280000955
-------------------------------------	--	------------------



- 3-way ratcheting tie-down strap with loop ends.
- Designed to securely hold spare tires on accessories equipped with integrated spare tire attachment points.
- Adjustable to accommodate most common UTV tire sizes.
- Ratchet and junction ring made of durable zinc-plated steel.
- Required for spare tire attachment on Adventure Roof Rack and LinQ Pivoting Rack (not compatible with Commander).

Heavy-Duty Ratchet Tie-Down	Commander, Commander MAX, Maverick Trail, Maverick Sport, Maverick Sport MAX	715008308
------------------------------------	--	------------------



- 1,000 lb (454 kg) safe working load.
- 1.5 in. x 6 in. (38 mm x 1.8 mm) strap with BRP brands.
- Deluxe ratchet with rubber handle.
- Black-coated clip hooks.
- 12" (300 mm) webbing included.
- Pack of two.

Bolt-On¹ Retractable Ratcheting Tie-Downs	Commander, Commander MAX, Maverick Trail, Maverick Sport, Maverick Sport MAX	295101072
---	--	------------------



- Perfect for transporting your powersport vehicle or securing loads.
- Mounts easily: Bolts on any flat surface (e.g., truck bed or frame).
- 1" x 6' (2.5 cm x 1.8 m) tie-down strap with heavy-duty stitching that delivers a 500 lb (226 kg) working load strength and 1,500 lb (680 kg) break strength.
- Convenient retractable push button automatically slackens, spools and stores away strap, while the ratchet mechanism tightens the strap snugly to secure your vehicle or load into place.
- Rubber ratcheting handle provides firm grip, and the hook is vinyl coated to protect whatever surface it hooks into.
- Sold in pairs.

Ratchet Tie-Downs	Commander, Commander MAX, Maverick Trail, Maverick Sport, Maverick Sport MAX	715008309 · Black/Grey
--------------------------	--	-------------------------------



- 400 lb (181 kg) safe working load.
- 1" x 10' (2.5 cm x 3 m) strap with Sea-Doo, Ski-Doo and Can-Am logos.
- Deluxe ratchet with rubber handle.
- Coated S hooks.
- Pack of 2.

LIGHTS

2 CHOOSE YOUR LIGHTS									
1 CHOOSE YOUR MOUNT POINT	BAJA DESIGNS' LIGHTS				CAN-AM LIGHTS				
	10" (25 cm) LED light bar	XL Sport LED lights (sold in pairs)	Squadron Sport LED lights (sold in pairs)	XL80 LED lights (sold in pairs)	10" double stacked LED bar	15" double stacked LED bar	39" double stacked LED bar	4" round LED lights (sold in pairs)	3.5" spot or flood LED lights (sold in pairs)
	Consult p. 49 information on Baja Designs lights.				Consult p. 50 for information on Can-Am lights.				
XT & X mr Front Bumper <i>(Stock on XT, XT-P and X mr)</i>	710006819 + 715007049 (Power Cable)	710006821 + 715002884 (Power Cable)	710006820 + 715002884 (Power Cable)	710005041 + 715003729 (Power Cable)	715002933 + 715003670 (Power Cable)	715002934 + 715003670 (Power Cable)	NA	715002935 (4" Round), 715003665 (3.5" Flood) or 715003666 (3.5" Spot) + 715003670 (Power Cable)	
Trail Bumper & Rancher Bumper	NA	710006821 + 715002884 (Power Cable)	710006820 + 715002884 (Power Cable)	710005041 + 715003729 (Power Cable)	715002933 + 715003670 (Power Cable)	NA	NA	715002935 (4" Round), 715003665 (3.5" Flood) or 715003666 (3.5" Spot) + 715003670 (Power Cable)	
DragonFire Racing Front Bumper	NA	NA	NA	NA	715002933 + 715003670 (Power Cable)	NA	NA	715002935 (4" Round), 715003665 (3.5" Flood) or 715003666 (3.5" Spot) + 715003670 (Power Cable)	
Front Bumper	710006819 + 715007049 (Power Cable)	710006821 + 715002884 (Power Cable)	710006820 + 715002884 (Power Cable)	710005041 + 715003729 (Power Cable)	NA	715002934 + 715003670 (Power Cable)	NA	715002935 (4" Round), 715003665 (3.5" Flood) or 715003666 (3.5" Spot) + 715003670 (Power Cable)	
Sport Roof & Bimini Roof	710006819 + 715007049 (Power Cable) *Optional Overhead Switch Panel 715003669	710006821 + 715002884 (Power Cable) *Optional Overhead Switch Panel 715003669	710006820 + 715002884 (Power Cable) *Optional Overhead Switch Panel 715003669	710005041 + 715007049 (Power Cable) *Optional Overhead Switch Panel 715003669	715002933 + 715003670 (Power Cable) + 715003669 (Overhead Switch Panel)	715002934 + 715003669 (Overhead Switch Panel)	715004007 + 715005822 (Mounting Kit)	715002935 (4" Round), 715003665 (3.5" Flood) or 715003666 (3.5" Spot) + 715003669 (Overhead Switch Panel)	
Top Roll Cage & DragonFire Aluminum Roof	NA	NA	NA	NA	NA	NA	715004007 + 715005822 (Mounting Kit)	NA	NA
Lonestar Racing Aluminum Roof	NA	NA	NA	NA	NA	NA	715004007 + 715004877 (Light Mounts) and 715005822 (Mounting Kit)	NA	NA
Sport Roof Back Position	NA	NA	NA	NA	NA	NA	NA	NA	715003665 or 715003666 + 715003669 + 715004910

*All lights are intended for off-road use only.

Baja Designs Light Power Cable <i>(Not illustrated)</i>	Commander, Commander MAX Maverick Trail, Maverick Sport, Maverick Sport MAX	715002884
<ul style="list-style-type: none"> Required for installation of Baja Designs LED lights onto roof or bumper. Baja Designs XL Sport LED Lights and Baja Designs Squadron Sport LED Lights. 		
Baja Designs Light Power Cable <i>(Not illustrated)</i>	Commander, Commander MAX Maverick Trail, Maverick Sport, Maverick Sport MAX	715007049
<ul style="list-style-type: none"> Required for installation of Baja Designs LED lights onto roof or bumper. 10" (25 cm) Baja Designs OnX6 LED Bars and Baja Designs XL80 LED Lights. 		
Baja Designs Light Power Cable <i>(Not illustrated)</i>	Maverick Trail, Maverick Sport, Maverick Sport MAX	715003729
<ul style="list-style-type: none"> Required for installation of Baja Designs XL80 LED Light onto roof or bumper. 		

Baja Designs 10" (25 cm) OnX6 LED Light Bar

Commander, Commander MAX
Maverick Trail, Maverick Sport,
Maverick Sport Max

710006819

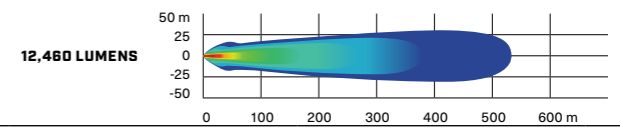
12,460 LUMENS

- 108 W light bar producing 12,460 lumens.
- Equipped with 6 Cree XM-L2 LEDs.
- Driving/combo light pattern for smooth blend of light for both near field applications and distance.
- Dual intensity (high/low) settings.
- Requires Baja Designs Light Power Cable.
- See table for installation location and requirements.
- Not EC compliant.

Baja Designs XL80 LED Lights

Commander, Commander MAX
Maverick Trail, Maverick Sport,
Maverick Sport Max

710005041

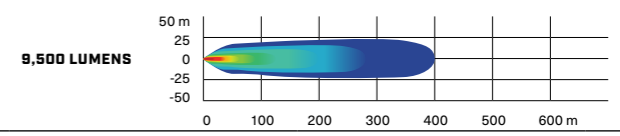
9,500 LUMENS

- 80 W per spot producing 9,500 lumens.
- Equipped with 4 Cree XHP50 LEDs per spot.
- Dual intensity (high/low) settings.
- Driving/combo light pattern for smooth blend of light for both near field applications and distance.
- Require Baja Designs Light Power Cable.
- Sold in pairs.
- Dimensions: 4.5" x 4.5" (11.4 cm x 11.4 cm).
- Not EC compliant.

Baja Designs Squadron Sport LED Lights

Commander, Commander MAX
Maverick Trail, Maverick Sport,
Maverick Sport Max

710006820

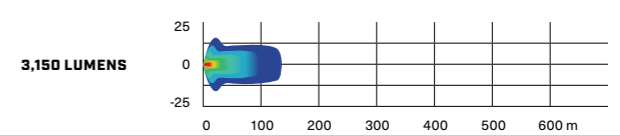
3,150 LUMENS

- 26 W per spot producing 3,150 lumens.
- Equipped with 4 Cree XP-G2 LEDs per spot.
- Wide cornering light pattern designed specifically for cornering, dust and/or fog conditions.
- Require Baja Designs Light Power Cable.
- Sold in pairs.
- Dimensions: 3" x 3" (7.6 cm x 7.6 cm).
- Not EC compliant.

Baja Designs XL Sport LED Lights

Commander, Commander MAX
Maverick Trail, Maverick Sport,
Maverick Sport Max

710006821

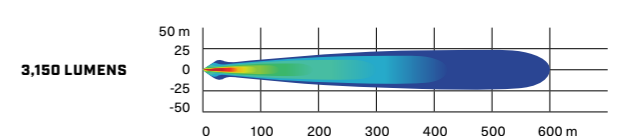
3,150 LUMENS

- 26 W per spot producing 3,150 lumens.
- Equipped with 4 Cree XP-G2 LEDs per spot.
- High Speed Spot features a longer and narrower beam focus for illumination farther down.
- Require Baja Designs Light Power Cable.
- Sold in pairs.
- Dimensions: 4.5" x 4.5" (11.4 cm x 11.4 cm).
- Not EC compliant.

10" (25 cm) Double Stacked LED Light Bar (60 W)

Commander, Commander MAX
Maverick Trail, Maverick Sport,
Maverick Sport Max

715002933

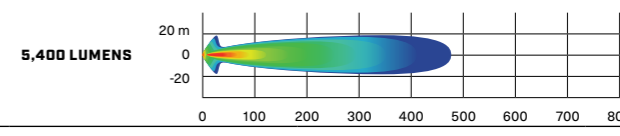

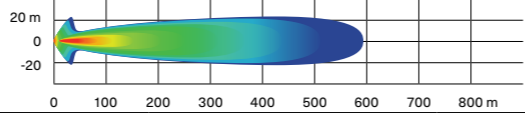

5,400 LUMENS

- Equipped with twelve 5 W Cree LEDs.
- 5,400 lumens.
- Packs a big punch for its size.
- Rugged and waterproof.
- Can be installed in stock XT and XT-P bumpers.
- Requires light power cable for installation.
- Lights up to more than 1,500 ft (460 m) in front of the vehicle and around 65 ft (20 m) wide on each side.
- Not EC compliant.

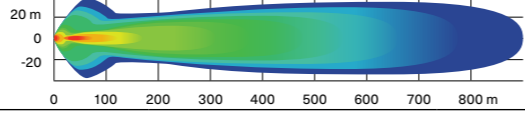
15" (38 cm) Double Stacked LED Light Bar (90 W)	Commander, Commander MAX Maverick Trail, Maverick Sport, Maverick Sport Max	715002934
 <ul style="list-style-type: none"> Equipped with 18 5 W Cree LEDs. 8,400 lumens. Complements the Light Racks and most bumpers. Rugged and waterproof. 	 <p>8,400 LUMENS</p> <ul style="list-style-type: none"> Lights up to more than 1900 ft (580 m) in front of the vehicle and around 65 ft (20 m) wide on each side. Not EC compliant. 	

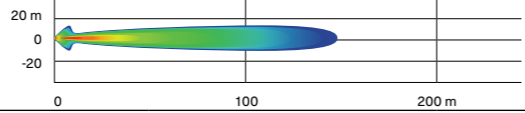
39" (99 cm) Double Stacked LED Light Bar (270 W)	Commander, Commander MAX Maverick Trail, Maverick Sport, Maverick Sport Max	715004007
 <ul style="list-style-type: none"> Equipped with 54 5 W Cree LEDs. 24,300 lumens. 	 <p>24,300 LUMENS</p> <ul style="list-style-type: none"> Not compatible with Full Windshield, Flip Windshield and Can-Am Intrusion Bar. Lights up to more than 2900 ft (900 m) in front of the vehicle and around 115 ft (35 m) wide on each side. Not EC compliant. 	

4" (10 cm) Round LED Lights (2 x 25 W)	Commander, Commander MAX Maverick Trail, Maverick Sport, Maverick Sport Max	715002935
 <ul style="list-style-type: none"> 25 W LED spotlights. 1,800 lumens. Rugged and waterproof. Includes basic wiring and switch. 	 <p>1,800 LUMENS</p> <ul style="list-style-type: none"> Can-Am branded grill. Requires light power cable. Sold in pairs. Not EC compliant. 	

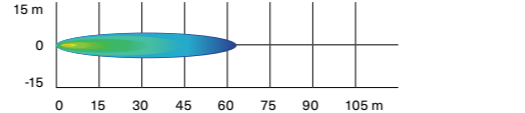
3.5" (9 cm) LED Driving Lights (2 x 14 W)	Commander, Commander MAX Maverick Trail, Maverick Sport, Maverick Sport Max	715003666
 <ul style="list-style-type: none"> 14 W LED lights producing 1,260 lumens each. Spot lens for a narrow and long light beam spread, ideal when driving at higher speeds. Equipped with six high-power LEDs in a heavy-duty die-cast aluminum housing. 	 <p>1,260 LUMENS</p> <ul style="list-style-type: none"> Features two attachment points. If one attachment point fails due to a collision, rotate to the next channel point and remount the light. Sold in pairs. CE certified 	

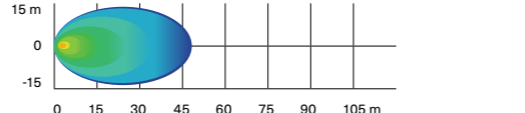
3.5" (9 cm) LED Flood Lights (2 x 14 W)	Commander, Commander MAX Maverick Trail, Maverick Sport, Maverick Sport Max	715003665
 <ul style="list-style-type: none"> 14 W LED lights producing 1,260 lumens each. Flood lens for a wide light beam spread, ideal for working applications like plowing or cornering. Suitable for dusty or foggy riding conditions. Equipped with six high-power LEDs in a heavy-duty die-cast aluminum housing. 	 <p>1,260 LUMENS</p> <ul style="list-style-type: none"> Features two attachment points. If one attachment point fails due to a collision, rotate to the next channel point and remount the light. Sold in pairs. CE certified 	

Light Power Cable <i>(Not illustrated)</i>	Commander, Commander MAX Maverick Trail, Maverick Sport, Maverick Sport Max	715003670
<ul style="list-style-type: none"> Power cable for installation of compatible Can-Am light kits on Front Bumpers. 		

LED Headlights Assembly	Commander, Commander MAX Maverick Trail, Maverick Sport, Maverick Sport MAX	715003667
 <ul style="list-style-type: none"> The headlights in this upgrade kit draw a maximum of 40 W (2 x 20 W) of power while providing brighter light output. 		<ul style="list-style-type: none"> Lower power consumption and longer lasting than standard halogen bulbs. Not EC compliant.

LED Signature Lights	Commander, Commander MAX	715006896
 <ul style="list-style-type: none"> The stylish LED set adds a finishing touch, accentuating its aggressive stance. 		

Can-Am LED Signature Lights	Maverick Trail, Maverick Sport, Maverick Sport MAX	715003673
 <ul style="list-style-type: none"> Add style with a more aggressive look. Use bright and energy efficient LEDs. Do not give additional lighting for driving. 		

Dome Light	Commander, Commander MAX Maverick Trail, Maverick Sport, Maverick Sport MAX	715002455
 <ul style="list-style-type: none"> LED array integrates perfectly with vehicle. Wiring included. Can be installed on cage, Sport Roof or All-Terrain Trunk Cover. 		

Roof Tail Light	Commander, Commander MAX Maverick Trail, Maverick Sport, Maverick Sport MAX	715003668
 <ul style="list-style-type: none"> Roof mounted tail and brake light increases your visibility for following vehicles. Uses bright and energy efficient LEDs. Sport Roof is required for installation. Not EC compliant. 		

Lonestar Racing Mounts for 39" (99 cm) Double Stacked LED Light Bar	Commander, Commander MAX Maverick Trail, Maverick Sport, Maverick Sport MAX	715004877
 <ul style="list-style-type: none"> Low profile mounts allowing for the installation of the 39" (99 cm) Double Stacked LED Light Bar on the Lonestar Racing Aluminum Roof (sold separately). 		

Mounting Kit for 39" (99 cm) LED Light Bar <i>(Not illustrated)</i>	Commander, Commander MAX Maverick Trail, Maverick Sport, Maverick Sport MAX	715005822
<ul style="list-style-type: none"> Required for installation of the 39" (99 cm) double stacked LED Light Bar. Includes wiring and support bracket. Light Support Bar required for installation. 		

Roof Power Cable <i>(Not illustrated)</i>	Commander, Commander MAX Maverick Trail, Maverick Sport, Maverick Sport MAX	715003094
<ul style="list-style-type: none"> Brings power from the battery. Required for installation of some electrical accessories. 		

Rear Lights Power Cable <i>(Not illustrated)</i>	Commander, Commander MAX Maverick Trail, Maverick Sport, Maverick Sport MAX	715004910
<ul style="list-style-type: none"> Power cable that allows you to install rear cargo lights on your vehicle. Use in conjunction with the 3.5" (9 cm) LED Flood Lights (2 x 14 W) (sold separately). This set-up will illuminate your rear cargo area and surroundings. Sport Roof and Overhead Switch Panel (715003669) required. 		

AUDIO & COMMUNICATION SYSTEMS

AUDIO

Complete Wet Sounds[†] Audio System	Commander, Commander MAX, Maverick Trail, Maverick Sport, Maverick Sport MAX	715003672
---	--	------------------



- Orchestrated for outstanding sound quality and the playlists of champions.
- Built-in 200 W amplifier with D-Bass Tech for improved low end bass response.
- Built-in Bluetooth[†] connectivity with source control.
- Aux input allows for use with non-Bluetooth devices.
- Turns itself off after 10 minutes of inactivity to save battery power.
- Designed to be Can-Am-tough in the most demanding riding conditions.
- Includes 4.5" (11.4 cm) front and 6.5" (16.5 cm) rear-roll-cage mounted stereo speakers and console integrated backlit control panel.

Wet Sounds Stealth 6 Ultra HD Can-Am Edition Sound Bar	Commander, Commander MAX, Maverick Trail, Maverick Sport, Maverick Sport MAX	710006028
---	--	------------------



- Built-in 200 W amplifier with D-Bass Tech for improved low end bass response.
- Full range speaker array plus additional titanium dome tweeters for dynamic output and performance.
- HD High Output drivers with new composite high stiffness frames.
- Built-in Bluetooth connectivity with source control.
- RF wireless remote for full control from steering wheel cradle.
- Aux input allows for use with non-Bluetooth devices.
- Turns itself off after 10 minutes of inactivity to save battery power.
- Backlit control panel.
- 2V line-output allows for hooking up another sound bar or adding an external amplifier and speakers.
- IP67 rated for better protection against the elements.
- Powder coat finish for extra durability and resistance to the elements.
- Requires sound bar mount kit (715004745).

Can-Am Subwoofer	Commander, Commander MAX, Maverick Trail, Maverick Sport, Maverick Sport MAX	715006359
-------------------------	--	------------------



- Powerful Wet Sounds 8" Subwoofer speakerbox that fits in the glove box.
- Easy plug-and-play connections to Wet Sounds audio system.
- Sturdy construction, tough enough to withstand harsh environments and sealed against moisture and dirt.
- 350 W amplifier and wiring included.

Electronic Device Holder	Commander, Commander MAX, Maverick Trail, Maverick Sport, Maverick Sport MAX	715005212
---------------------------------	--	------------------



- A great in-ride entertainment system platform.
- Robust injected-polypropylene construction allows for right fit and easy installation.
- Adjustable unit safely holds most tablets and smartphones measuring between 5.1" (13 cm) and 10" (25.4 cm) (with protective case).
- Allows the installation of Garmin Montana 680T GPS.
- Perfectly complements the Wet Sounds audio systems or Rugged Radios Intercom System to play music with your device.
- Integrated storage (2.5 gal (9.5 L) capacity) with access to the dash 12V outlet for device charging.
- Integrated mounting location for RAM mounts.
- Not compatible with Defrost, Heat and Ventilation System (715003678).

Sound Bar Mount Kit <i>(Not illustrated)</i>	Commander, Commander MAX, Maverick Trail, Maverick Sport, Maverick Sport MAX	715004745
--	--	------------------

- Required mount kit for the Wet Sounds Stealth 6 Ultra HD Can-Am Edition Sound Bar (710006028).

COMMUNICATION SYSTEMS

Rugged Radios Car-to-Car System	Commander, Commander MAX, Maverick Trail, Maverick Sport, Maverick Sport MAX	715003440 • US only
--	--	----------------------------



- Perfect for communicating with friends and family on group rides.
- Push-to-talk button conveniently mounted on the steering wheel.
- May be connected with the Rugged Radios Intercom System (with provided adaptor cable).
- This kit includes:
 - 5-Watt V3 Radio: UHF/VHF + FM Frequency, Programmable Channels, 5 Watts of Power, Includes Belt Clip, Recharging Cable, High capacity, all day lithium-ion battery, 1-3 Mile range, NOAA weather channels, 1-Touch FM radio, Backlit screen/buttons.
 - Helmet Speaker/Mic Kit: Clear Hear Audio Speakers, Full Flex Mic Boom, Cloth Mic Cover, Velcro Mount Speakers, Quick & Easy Install.
 - Harness & Cables: Single Person Harness, Driver Coil Cord PTT, Waterproof PTT, Radio Mounting Bracket, Complete Plug & Play Kit.

Rugged Radios Intercom System	Commander, Commander MAX [†] , Maverick Trail, Maverick Sport, Maverick Sport MAX [†]	715002891 • US only
--------------------------------------	---	----------------------------



- Specifically designed to facilitate clear in-vehicle communication between driver and passenger(s).
- Expandable to 4 people.
- Includes music port for enjoying your favorite tunes.
- Seamless integration with in-dash switch panel.
- May be synched with the Rugged Radios Car-to-Car System.

[†]Power Cable (715003094) is required for installation on MAX models.

Rugged Radios Helmet Headset Kit for Rear Passengers	With Rugged Radios Intercom System	715004380 • US only
---	------------------------------------	----------------------------



- Additional 12' (3.7 m) cables and Helmet Speaker/Mic Kits to upgrade your 2-person intercom system to a 4-person system.

[†]Power Cable (715003094) is required for installation on MAX models.

ELECTRICAL & ELECTRONIC ACCESSORIES

ELECTRICAL

Defrost, Heat and Ventilation System	Commander, Commander MAX, Maverick Trail, Maverick Sport, Maverick Sport MAX	715003678
---	--	------------------





- Best integrated system on the market with 3 ventilation speeds and in-dash adjustable temperature.
- Adjustable/directional vents.
- 5 vents specially positioned for better windshield defrosting and passenger comfort.
- Automotive-style heater core and fan for best heating performance.
- Smart-Lok equipped vehicles require Adaptor Kit (715007241).

Heated Steering Wheel	Commander, Commander MAX, Maverick Trail, Maverick Sport, Maverick Sport MAX	715004283
------------------------------	--	------------------



- Ruggedly constructed steering wheel designed to withstand cold conditions while channeling heat directly to your hands.
- Perfect for making hand mobility and grip readily available, e.g., hunting, manual farming.
- Replaces stock steering wheel.
- This kit includes the heated steering and in-dash switch.
- Heated Accessories Wiring Harness (710005757) is required.
- Draws a maximum of 45 W and 3.2 A at 13.5 W.
- Not EC compliant.

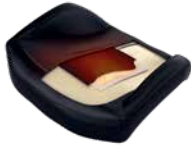





ELECTRICAL

<p>Heated Grab Bar Cover</p> 	<p>Commander, Commander MAX, Maverick Trail, Maverick Sport, Maverick Sport MAX</p>	<p>715004500</p>
<ul style="list-style-type: none"> • Made tough to hold up to the stresses of rough riding, this heated cover will keep your passenger's hands warm and securely gripped during long, cold outings. • Easy to install and remove. • This kit includes the heated grab bar cover and in-dash switch. • Heated Accessories Wiring Harness (710005757) is required. • Draws a maximum of 25 W and 1.8 A at 13.5 W. 		
<p>Seat Heater</p> 	<p>Commander, Commander MAX, Maverick Trail, Maverick Sport, Maverick Sport MAX</p>	<p>715006112</p>
<ul style="list-style-type: none"> • 25 W seat heater delivers chill-free riding comfort. • High/low temperature settings allow you to control the desired degree of warmth. • This kit includes one carbon fiber seat heater, foam sheet and in-dash switch. • Installs directly in the original seat cushion. • Heated Accessories Wiring Harness (710005757) is required for front seat installation. • Heated Accessories Wiring Harness (715006004) is required for rear seat installation. 		
<p>12v Power Outlet</p> 	<p>Commander, Commander MAX, Maverick Trail, Maverick Sport, Maverick Sport MAX</p>	<p>715003846</p>
<ul style="list-style-type: none"> • 12V accessories outlet. • Easy plug-in harness included. 		
<p>Heated Visor Outlet</p> 	<p>Commander, Commander MAX, Maverick Trail, Maverick Sport, Maverick Sport MAX</p>	<p>715001246</p>
<ul style="list-style-type: none"> • Strategically positioned on vehicle to maintain your agility. • Optional visor outlet that delivers fog-free riding. • Quick and easy installation. • Sold individually. • Heated Visor not included. 		
<p>Heated Accessories Wiring Harness <i>(Not illustrated)</i></p>	<p>Commander, Commander MAX, Maverick Trail, Maverick Sport, Maverick Sport MAX</p>	<p>710005757</p>
<ul style="list-style-type: none"> • Electric harness required to hook up and operate front heated seats, heated steering wheel and heated grab bar. 		
<p>Heated Accessories Wiring Harness <i>(Not illustrated)</i></p>	<p>Commander MAX, Maverick Sport MAX</p>	<p>715006004</p>
<ul style="list-style-type: none"> • Electric harness required to hook up and operate rear heated seats. 		
<p>Heater Adaptor Kit for Smart-Lok <i>(Not illustrated)</i></p>	<p>Commander, Commander MAX, Maverick Trail, Maverick Sport, Maverick Sport MAX</p>	<p>715007241</p>
<ul style="list-style-type: none"> • Adaptor kit to fit heating system on Smart-Lok equipped vehicles. 		

ELECTRONIC ACCESSORIES



<p>Garmin[†] Montana[†] 680T GPS</p> 	<p>Commander, Commander MAX, Maverick Trail, Maverick Sport, Maverick Sport MAX</p>	<p>715003456 EU 715002830</p>
<ul style="list-style-type: none"> • Rugged and waterproof, the Montana 680T is element-proof. • 4" (10.16 cm) dual-orientation, sunlight-readable touchscreen and glove-friendly touchscreen display, to give you vivid colors and high-resolution images. • 8-megapixel autofocus camera automatically geotags photos. • Tracks both GPS and GLONASS satellites for improved positioning and typically faster fixes. • Preloaded TOPO maps, plus 1-year BirdsEye Satellite Imagery subscription. • 3-axis compass with barometric altimeter. • Electronic device holder(715002874) is required for installation. • Includes a preloaded map for US. • European Version (EC compliant). • Includes preloaded European recreation map (715003456). 		
<p>RAM[†] GPS Mount</p> 	<p>Commander, Commander MAX, Maverick Trail, Maverick Sport, Maverick Sport MAX</p>	<p>715003325</p>
<ul style="list-style-type: none"> • Allows for GPS integration onto vehicle. • Standard AMPS hole pattern for Garmin Cradle. 		
<p>USB Power Outlet Kit</p> 	<p>Commander, Commander MAX, Maverick Trail, Maverick Sport, Maverick Sport MAX</p>	<p>219400510</p>
<ul style="list-style-type: none"> • Recharges your electronic devices while riding[‡] (smartphone, MP3, heating gear, etc.). • Dual port USB connectors. <p><i>‡The power outlet is not capable of recharging all device types while riding.</i></p>		
<p>Adjustable Lighted Whip Flag</p> 	<p>Commander, Commander MAX, Maverick Trail, Maverick Sport, Maverick Sport MAX</p>	<p>715005437</p>
<ul style="list-style-type: none"> • A must for riding the dunes. • 5W Cree LED. • 5 colored lenses to allow personalization. • Glow-through whip, quickly removable and replaceable pole. • Increases vehicle's visibility. • Meets most dune-area requirements. • Die-cast aluminum base, acetal hand nut. • Includes adjustable mounting brackets and wiring. 		
<p>Overhead Switch Panel</p> 	<p>Commander, Commander MAX, Maverick Trail, Maverick Sport, Maverick Sport MAX</p>	<p>715003669</p>
<ul style="list-style-type: none"> • Fully integrated Overhead Switch Panel gives additional switch spots for electrical accessories. • Required for Can-Am lights installation on the roof and for other top-mounted electrical accessories. • Optional for Baja Designs lights. • Requires Sport Roof or Bimini Roof with Sun Visor for installation. 		
<p>Dual Mode Switch</p> 	<p>Commander, Commander MAX, Maverick Trail, Maverick Sport, Maverick Sport MAX</p>	<p>715004736</p>
<ul style="list-style-type: none"> • Switches quickly and conveniently between normal and eco modes. • Eco mode increases fuel economy. • In-dash plug-and-play mount. • Standard on DPS models. 		

ELECTRONIC ACCESSORIES



<p>30 Ah Battery Holder</p> 	<p>Commander, Commander MAX, Maverick Trail, Maverick Sport, Maverick Sport MAX</p>	<p>715004431</p>
<ul style="list-style-type: none"> • Fixation plate designed to hold the 30 Ah Battery (515176151). • 30 Ah Battery sold separately. 		
<p>Battery Charger/Maintainer</p> 	<p>Commander, Commander MAX, Maverick Trail, Maverick Sport, Maverick Sport MAX</p>	<p>715005061</p>
<ul style="list-style-type: none"> • Keeps stored lead-acid batteries charged. • Charges and maintains small batteries. • Microprocessor controlled multi-stage charging for added precision, safety and battery life. • Automatically detects 6 or 12 volt batteries. • Reverse hook-up protection helps protect battery and charger from damage. • Auto-voltage detection. • Press the display button to show the charge progress. • Content: 3 Amp battery charger, clamp adapter, DC adapter, 24" (61 cm) fused ring leads harness with weather cap, owner's manual. • US plug (110V) • Not available in Europe. 		
<p>Jump Starter</p> 	<p>Commander, Commander MAX, Maverick Trail, Maverick Sport, Maverick Sport MAX</p>	<p>715005062</p>
<ul style="list-style-type: none"> • IPX3 water-resistant and enclosed output ports. • 4 LED battery indicators for easy read on battery charge level. • Compact design, will conveniently fit in your backpack, glove box or any other storage compartment. • 2.4A + 1A / 5V USB ports for fast charging of all USB devices. • Smart cable provides protection against reverse polarity, short circuit, low voltage, high temperature and reverse charging. • Built-in LED light (3 modes). • Content: 300CA jump starter, SA858 smart cable clamp, MC-USB to USB charging cable, travel bag, user manual. • Not available in Europe 		
<p>Quick Connect Battery Cable</p> 	<p>Commander, Commander MAX, Maverick Trail, Maverick Sport, Maverick Sport MAX</p>	<p>715005408</p>
<ul style="list-style-type: none"> • Quickly and easily connect and charge different batteries with your charger. • Included in the Battery Charger/Maintainer. • Sold individually. • Not available in Europe 		
<p>Quick Connect Cable with Battery Indicator</p> 	<p>Commander, Commander MAX, Maverick Trail, Maverick Sport, Maverick Sport MAX</p>	<p>715006055</p>
<ul style="list-style-type: none"> • Quickly and easily connect and charge different batteries with your charger. • 3-color LED indicator provides constant battery health indication. • Sold individually. • Not available in Europe 		
<p>Digitally Encoded Security System (D.E.S.S.) Keys</p> 	<p>Commander, Commander MAX, Maverick Trail, Maverick Sport, Maverick Sport MAX</p>	<p>715002458</p>
<ul style="list-style-type: none"> • Top-security anti-theft protection for your vehicle. • Encrypted chip technology restricts access to your vehicle's electronic ignition system. • One vehicle/one code. • A vibration/shock-resistant ball-and-socket design that ensures a reliable connection. • 3 programmable modes: <ul style="list-style-type: none"> - Work mode: Limits vehicle speed to 40 kph (25 mph) but does not limit engine torque. - Normal mode: Limits vehicle speed to 70 kph (44 mph) and 50% torque reduction. - Performance mode: No restrictions. • C-TEK charger 860200997. See last year's catalogue for details. 		
<p>Ctek Brp 5.0 Battery Charger</p> 	<p>860200997</p>	
<ul style="list-style-type: none"> • CTEK, the manufacturer of the smartest battery chargers in the world, has produced a BRP specific charger for all BRP products. • Charger is built to meet the demanding arctic conditions. • Ask your dealer for more information. 		

WINCHES & HITCHES

CAN-AM HD WINCHES

<p>Can-Am HD 4500 Winch</p> 	<p>Commander, Commander MAX, Maverick Trail, Maverick Sport, Maverick Sport MAX</p>	<p>715006416</p>
<ul style="list-style-type: none"> • Ergonomic clutch handle. • Rugged all-steel gears and bushings for more torque and durability. • Automatic 100% load-holding brake. • Sealed solenoid for all-weather protection. • Weather sealed corded remote and dash mounted switch. • EC compliant. • Pulling strength capability of 4,500 lb (2,041 kg). • 43' of 1/8" (13.1 m of 6.3 mm) wire steel cable. • Heavy-duty 4-way roller fairlead. • Commander and Commander MAX: Winch Electrical Harness (715007078) is required for installation on Base and DPS models. 		
<p>Can-Am HD 4500-S Winch</p> 	<p>Commander, Commander MAX, Maverick Trail, Maverick Sport, Maverick Sport MAX</p>	<p>715006417</p>
<ul style="list-style-type: none"> • Ergonomic clutch handle. • Rugged all-steel gears and bushings for more torque and durability. • Automatic 100% load-holding brake. • Sealed solenoid for all-weather protection. • Weather sealed corded remote and dash mounted switch. • Pulling strength capability of 4,500 lb (2,041kg). • 50' of 1/4" (15.2 m of 6.35 mm) synthetic rope. • Corrosion-proof aluminum hawse fairlead. • Commander and Commander MAX: Winch Electrical Harness (715007078) is required for installation on base and DPS models. 		

WARN® VRX WINCHES

<p>WARN VRX 45 Winch</p> 	<p>Commander, Commander MAX, Maverick Trail, Maverick Sport, Maverick Sport MAX</p>	<p>715006110</p>
<ul style="list-style-type: none"> • Extreme IP68-rated waterproof sealing keeps the elements out. • Durable all-metal construction. • Black powder-coated finish and stainless steel fasteners for corrosion resistance. • Robust new clutch design based on 70+ years of WARN 4 WD hub lock know-how. • Load-holding brake for great control. • Smooth and reliable all-metal three-stage planetary gear train. • Dash-mounted rocker control. • Limited lifetime warranty (mechanical), 3-year warranty (electrical). • Pulling strength capability of 4,500 lb (2,041 kg). • 50' of 1/4" (15 m of 6.3 mm) wire steel cable. • Roller fairlead. 		
<p>WARN VRX 45-S Winch</p> 	<p>Commander, Commander MAX, Maverick Trail, Maverick Sport, Maverick Sport MAX</p>	<p>715006111</p>
<ul style="list-style-type: none"> • Extreme IP68-rated waterproof sealing keeps the elements out. • Durable all-metal construction. • Black powder-coated finish and stainless steel fasteners for corrosion resistance. • Robust new clutch design based on 70+ years of WARN 4 WD hub lock know-how. • Load-holding brake for great control. • Smooth and reliable all-metal three-stage planetary gear train. • Dash-mounted rocker control. • Limited lifetime warranty (mechanical), 3-year warranty (electrical). • Pulling strength capability of 4,500 lb (2,041 kg). • 50' of 1/4" (15 m of 6.3 mm) synthetic rope. • Cast aluminum hawse fairlead. 		

WINCH ACCESSORIES

Can-Am HD Hawse Fairlead	Can-Am HD Winch	715006426
---------------------------------	-----------------	------------------



- A must when upgrading your winch with a synthetic cable, this corrosion-proof aluminum hawse fairlead will prevent the cable from snapping in a corner of a roller fairlead and from wearing prematurely due to the rough surface of the worn roller guide.
- Must be used with synthetic cables only.

WARN Hawse Fairlead	WARN Winch	705204567
----------------------------	------------	------------------



- Double-powder-coated construction.
- Required to use the Synthetic Winch Cable (715001118) on WARN winches.
- To be used with synthetic winch cables only.

Roller Fairlead	WARN Winch	715001119
	Can-Am HD Winch	715007082



- Suggested when changing the wire rope.
- Heavy-duty replacement fairlead for winches.

Wire Rope Replacement	Can-Am HD Winch	705011595
------------------------------	-----------------	------------------



- 47' of 1/4" (14.3 m of 6.3 mm) wire rope.
- 4,500 lb (2,041 kg) pulling strength.

Synthetic Winch Cable	Can-Am HD Winch	715006430
------------------------------	-----------------	------------------



- 50' of 1/4" (15.2 m of 6.35 mm) synthetic cable for Can-Am HD winches.
- Can-Am HD Hawse Fairlead (715006426) is required when upgrading to a synthetic cable to avoid premature cable damage and wear.

Synthetic Winch Cable	WARN winch	715001118
------------------------------	------------	------------------



- 50' of 7/32" (15.2 m of 5.5 mm) synthetic cable for WARN winch.
- WARN Hawse Fairlead (705204567) is required when upgrading to a synthetic cable to avoid damage and premature wear of the cable.

Synthetic Cable Extension	Commander, Commander MAX, Maverick Trail, Maverick Sport, Maverick Sport MAX	715001120
----------------------------------	--	------------------



- Lightweight 1/4" (6.35 mm) diameter, easy to handle and won't rattle in cargo box.
- Easily attaches to winch cable to provide additional 50' (15.2 m) of distance.
- 4,500 lb (2,041 kg) single line capacity.

WINCH ACCESSORIES

Wired Remote Control	WARN Winch	710001002
	Can-Am HD Winch	715006504 (2020 & up) 710007050



- This kit allows winch owners to add the hand-held remote to vehicles with a stock winch.
- OEM stock winch and Wired Remote Control are sold separately.
- EC compliant.

Wireless Remote Control	WARN Winch	715002542
--------------------------------	------------	------------------



- The system is quick and easy to install, thanks to a wiring harness with an integrated antenna and all necessary mounting hardware.
- Allows you to operate your winch from anywhere within a 50' (15.2 m) radius, increasing your recovery options.
- All components are weatherproof.

X rc/X mr Front Tow Hook	Commander, Commander MAX, Maverick Trail, Maverick Sport, Maverick Sport MAX	715005229
---------------------------------	--	------------------



- Offers a solid place to hook onto in case towing is needed.
- Allows you to attach most straps and hooks.
- Made of rugged 1/8" (3 mm) steel plate and 3/8" (11 mm) steel hook tube.
- Standard on Maverick X rc and X mr models.

HITCHES



Front Receiver Hitch	Commander, Commander MAX, Maverick Trail, Maverick Sport, Maverick Sport MAX	715003642
-----------------------------	--	------------------



- Heavy-duty 1,500 lb (680 kg) towing capacity 2" (5 cm) receiver hitch.
- Perfect for precision towing in small spaces.

PERFORMANCE

SMART-LOK TECHNOLOGY

Smart-Lok Differential	Maverick Trail, Maverick Sport, Maverick Sport MAX (2021 & prior)	705402371
 <ul style="list-style-type: none"> Can-Am-exclusive Smart-Lok technology constitutes a true fully lockable on-the-fly front differential with electronically controlled automatic modes. Choose your differential settings according to your riding need: "2x4" for rear wheel traction only, "4x4 Front Diff. Lock" for a fully locked 4 wheel drive, and "4x4 Smart Mode" that offers preset, intelligent calibrations for your type of riding. Using multiple input sources, "Smart Mode" will instantaneously engage locking with the right load at the right moment to procure maximum traction while retaining low-speed maneuverability, allowing for optimal placement and a feeling of confidence. The Smart-Lok Differential Kit comes standard with the Trail Mode. Mud, Rock and Trail Activ modes can be added by installing an additional Smart Mode Module (sold separately) to fine-tune your riding environment. Requires Performance Half Shafts (2x) and Smart-Lok Installation Kit for installation. 		
Smart-Lok Installation Kit <i>(Not illustrated)</i>	Maverick Trail, Maverick Sport, Maverick Sport MAX (2021 & prior)	715005330
<ul style="list-style-type: none"> Required to install the Smart-Lok Differential Kit. Includes all necessary hardware and wiring for Smart-Lok Differential installation. 		
Performance Half Shaft	Maverick Trail Maverick Sport, Maverick Sport MAX	705402423 705402281
 <ul style="list-style-type: none"> High-performance design ideal for off-road use, with superior protection in any riding usage. Includes CVs, shaft and boots with the best suited geometry for your Can-Am vehicle. Required to install the Smart-Lok Differential Kit. 		
Mud Smart Mode Module <i>(Not illustrated)</i>	Models with Smart-Lok Differential	715005282
<ul style="list-style-type: none"> This module allows you to add the Mud Smart Mode to vehicles with the Smart-Lok Differential Kit sold as an accessory or to change to the Mud Smart Mode on vehicles equipped with a standard Smart-Lok. The Mud Mode has been specially designed to deliver superior traction in the deepest mud holes. When high engine torque and/or slippage is detected, Smart-Lok will fully lock the front end. The system will stay locked until throttle release. Only one Smart Mode Module can be installed at a time. 		
Rock Smart Mode Module <i>(Not illustrated)</i>	Models with Smart-Lok Differential	715005283
<ul style="list-style-type: none"> This module allows you to add the Rock Smart Mode to vehicles with the Smart-Lok Differential Kit sold as an accessory or to change to the Rock Smart Mode on vehicles equipped with a standard Smart-Lok. The Rock Mode has been specially designed to help cross challenging rocks. When high engine torque is detected at low vehicle speed, Smart-Lok will progressively lock the front end and will stay engaged until throttle release to prevent wheel slippage and provide optimal traction. The progressive engagement allows for easier steering when maneuvering the vehicle. Only one Smart Mode Module can be installed at a time. 		
Trail Activ Smart Mode Module <i>(Not illustrated)</i>	Models with Smart-Lok Differential	715005284
<ul style="list-style-type: none"> This module allows you to add the Trail Activ Smart Mode to vehicles with the Smart-Lok Differential Kit sold as an accessory or to change to the Trail Activ Smart Mode on vehicles equipped with a standard Smart-Lok. The Trail Activ Mode has been designed for aggressive riding, delivering the ultimate cornering precision. When high engine torque and/or an increase in vehicle speed is detected, Smart-Lok will progressively engage the front end and maintain it engaged until throttle release or vehicle speed reduction. The progressive engagement allows for smoother and lower steering effort. Only one Smart Mode Module can be installed at a time. 		

EXHAUST AND AIR INTAKE

Yoshimura¹ Slip-On Exhaust	Maverick Sport, Maverick Sport Max (models with 1000R engine) Maverick Trail, Maverick Sport (Except models with 700 & 1000R engine)	715004452 715003716
 <ul style="list-style-type: none"> Developed in collaboration with Yoshimura. Made from 304-grade stainless steel. Sporty sound from a lighter-than-stock muffler. USDF/USDA approved spark arrester. EPA compliant. Not EC compliant. 		
Performance Air Filter by Twin AIR¹	Commander, Commander MAX, Maverick Sport, Maverick Sport Max (models with 700 & 1000R engine) Maverick Trail, Maverick Sport (except models with 1000R engine)	715002895 715003630
 <ul style="list-style-type: none"> The best choice for the harshest conditions. Multiple staged oiled filtering foam for superior dust retaining capacity with high airflow. Washable and reusable. 		
Engine and CVT Pre-Filter Kit <i>(Not illustrated)</i>	Commander, Commander MAX, Maverick Trail, Maverick Sport, Maverick Sport MAX	715004290
<ul style="list-style-type: none"> Adds extra protection to your engine and CVT in harsh riding conditions. Filter blocks particles larger than 0.005" (0.1 mm). Water repellent screen. Necessary to maintain the vehicle's warranty when tracks are installed. Recommended for winter riding conditions. Not compatible with Snorkel kit. 		
Snorkel Pre-Filter	Commander, Commander MAX, Maverick Trail, Maverick Sport, Maverick Sport MAX	715005598
 <ul style="list-style-type: none"> Pre-filter specifically for snorkels. Adds extra protection to your engine in harsh riding conditions. Helps keep air filter cleaner. Filter blocks particles larger than 0.005" (0.13 mm). Necessary to maintain vehicle warranty when tracks are installed. 		
Snorkel kit	Commander, Commander MAX (models with 1000R engine) Maverick Trail (except models with 700 engine), Maverick Sport, Maverick Sport MAX	715003705
 <ul style="list-style-type: none"> Raises point of engine and CVT air intakes so vehicle can be semi-submersed in water/mud without taking in water to the engine. Not compatible with S&B particle separator, LinQ pivoting rack, all rear intrusion bar and all rear panels and windows. Standard on Maverick Sport X mr models. Not EC compliant. 		
Heavy-Duty Spring kit	Maverick Trail	715004961
 <ul style="list-style-type: none"> This set of heavy-duty springs will stiffen your suspension. Perfect for reducing vehicle overall sag when shocks are under heavy demand: heavy loading and hauling or for snow clearing. Complete kit of 4 springs. 		
Shock Covers <i>(Not illustrated)</i>	Maverick Sport, Maverick Sport MAX	715002368
<ul style="list-style-type: none"> Soft covers for shocks with ventilation holes. Eliminate dust and dirt intrusion into the shock cylinder, reducing risk of damage. Sold in pairs. 		
EMERGENCY ACCESSORIES		
Emergency Kit	Commander, Commander MAX, Maverick Trail, Maverick Sport, Maverick Sport MAX	715006102
 <ul style="list-style-type: none"> Complete emergency kit provides all essential equipment and supplies to get out of most unfavorable situations powersport enthusiasts can find themselves in. Includes: Jumper Cables, Air Compressor, Tire Repair Kit, Ratchet Tie-Down, Duct Tape, Tow Strap 3,300 lb (1,500 kg), Zip-Ties, Cloth Rags. 		

APACHE TRACK SYSTEMS

WINTER TRACKS 1-YEAR WARRANTY

Apache Backcountry Track System	Commander, Commander MAX, Maverick Trail, Maverick Sport, Maverick Sport MAX	715005247
	<ul style="list-style-type: none"> Designed to deliver the best flotation level and deep-snow performance on the market. Contact patch is 23% bigger than the Apache 360 LT. Provides an impressive average ground clearance increase of 7" (18 cm), keeps the vehicle out of deep snow. 	<ul style="list-style-type: none"> Aggressive track design with 2" (5 cm) lug height for maximum traction on snow. Apache Backcountry Mounting Kit, Track DPS Module and Engine and CVT Pre-Filter are required. For winter use only. Track installation will affect vehicle width and length.

Apache Backcountry LT Track System	Commander, Commander MAX, Maverick Sport, Maverick Sport MAX	715005891
	<ul style="list-style-type: none"> Tracks designed to deliver the best snow performance on the market with unmatched flotation level and traction on snow surface. Large contact patch, 37% bigger than the Apache 360 LT. Impressive added ground clearance of 7" (18 cm) helps keep the vehicle over the snow. Lightweight snowmobile-inspired rail design. 	<ul style="list-style-type: none"> Aggressive track design with 2" (5 cm) lug height for maximum traction on snow. Apache Backcountry LT Mounting Kit, Track DPS Module and Engine and CVT Pre-Filter are required. Fine-tune your track system using extra Idler Wheels, Sliders with Vespel Inserts and Rail Ice Scratcher. For winter use only. Track installation will affect vehicle width and length.

Apache Backcountry Mounting Kit <i>(Not illustrated)</i>	Commander DPS, Commander XT (700 engine only), Maverick Sport, Maverick Sport MAX (except X mr, X rc, X xc models)	715004834
	Maverick Trail	715004285
	<ul style="list-style-type: none"> Required for installation of the Apache Backcountry Track System. Not compatible with HMWPE Front and Rear A-Arm Protectors and Skid Plates. DPS module and Pre-Filter not included. 	

Apache Backcountry Mounting Kit <i>(Not illustrated)</i>	Commander, Commander MAX (models produced after January 18, 2020, except DPS models), Maverick Sport with 64" base	715005493
	<ul style="list-style-type: none"> Required for installation of the Apache Backcountry Track LT System. DPS module and Pre-Filter are required and sold separately. Not compatible with HMWPE Front and Rear A-Arm Protectors and Skid Plates. 	

ACCESSORIES

Track DPS Module <i>(Not illustrated)</i>	Commander, Commander MAX 2021, Maverick Trail, Maverick Sport	715007338
	<ul style="list-style-type: none"> Innovative DPS module that ensures speedometer accuracy and optimized steering assist which make for perfect track control and riding ease. Required to install the Apache and Backcountry Track Systems. 	

Rail Ice Scratchers	Apache Backcountry Track System	860201728
	<ul style="list-style-type: none"> Provide additional lubrication in hard and icy conditions. Rail mounted, small, light. Design expands on coil concept to allow reversing without damage. Easily stored when not in use. Extend slider life. 	

YEAR-ROUND TRACKS 2-YEAR WARRANTY

Apache 360 LT Track System	Commander, Commander MAX, Maverick Trail, Maverick Sport, Maverick Sport MAX	715005103
	<ul style="list-style-type: none"> Multifunctional tracks designed to support heavy loads and to fit on most Can-Am off-road vehicles. Extra contact patch adjustment for better performance over rough terrain. Contact patch is 7% to 9% bigger than the Apache 360's. Average ground clearance of 16" (41 cm). 	
	<ul style="list-style-type: none"> 1" (2.5 cm) lugs in the front and 1.25" (3.2 cm) in the back. Apache 360 LT Mounting Kit, Track DPS Module and Engine and CVT Pre-Filter Kit are required. EC compliant. 	

Apache 360 LT Mounting Kit <i>(Not illustrated)</i>	Commander DPS, Commander XT (700 engine only), Maverick Sport, Maverick Sport MAX (except X mr, X rc, X xc models)	715004755
	Maverick Trail	715004833
	<ul style="list-style-type: none"> Required for installation of the Apache 360 LT Track System. DPS module and Pre-Filter not included. Not compatible with HMWPE Front and Rear A-Arm Protectors and Skid Plates. 	

Apache 360 LT Mounting Kit <i>(Not illustrated)</i>	Commander, Commander MAX (models produced after January 18, 2020, except DPS & XT 700 models), Maverick Sport X mr, X rc, X xc (64" base only)	715005492
	<ul style="list-style-type: none"> Required for installation of the Apache 360 LT Track System. DPS module and Pre-Filter not included. Not compatible with HMWPE Front and Rear A-Arm Protectors and Skid Plates. 	

ACCESSORIES

Idler Wheel Kit	Apache Backcountry Track System, rear tracks only	860201230 - 141 mm
	<ul style="list-style-type: none"> Reduces drag and rolling resistance. Includes 2 wheels, brackets and hardware. Add up to 2 kits per rear track. Can extend slider life in hardened snow conditions. 	

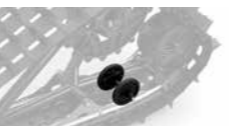
Apache Backcountry LT Wheel Kit	Apache Backcountry and Apache Backcountry LT Track System	715006293
	<ul style="list-style-type: none"> Additional wheel kit for Backcountry LT rear tracks. Reduces drag and rolling resistance in hard snow conditions or when transporting heavier loads. Extends slider life in hard snow conditions. Includes two wheels, cross shaft and mounting hardware per kit to service one track corner. Up to two kits per rear track can be installed. 	

Sliders with Vespel[®] Inserts	Apache Backcountry and Apache Backcountry LT Track Systems	503194815
	<ul style="list-style-type: none"> Use DuPont Vespel inserts for less friction. Longer life. Can be cut to desired length. 8 needed per vehicle. Sold individually. 	

ProMount PLOWS

CAN-AM ProMount STEEL PLOW KITS

Can-Am ProMount Steel 66" (168 cm) Plow Kit	Commander, Commander MAX, Maverick Trail, Maverick Sport, Maverick Sport MAX	<ul style="list-style-type: none"> 715007775 • Black 715008174 • Yellow
Can-Am ProMount Steel 72" (183 cm) Plow Kit	Commander, Commander MAX, Maverick Trail, Maverick Sport, Maverick Sport MAX	<ul style="list-style-type: none"> 715007777 • Black 715008173 • Yellow



- These kits include:
 - Can-Am ProMount Steel Blade.
 - Push Frame with Quick-Attach System.
 - Can-Am ProMount Mounting Plate.

CAN-AM ProMount STEEL BLADES

Can-Am ProMount Steel 66" (168 cm) Blade	Fits ProMount Push Frame	<ul style="list-style-type: none"> 715006337 • Black 715006338 • Yellow
---	--------------------------	---



- Plow blade made from 12-gauge steel.
- Replaceable wear blade.
- Large pin designed for easy blade rotation to eliminate snow buildup at pivot point.
- Blade design provides best snow roll-off at any angle.
- Clears 60" (152 cm) when plow is fully angled.
- Blade height of 17" (43 cm).
- Compatible with Can-Am ProMount Blade accessories to further enhance plow versatility.
- Not compatible with S3 High Clearance Front A-Arm.

Can-Am ProMount Steel 72" (183 cm) Blade	Fits ProMount Push Frame	<ul style="list-style-type: none"> 715004474 • Black 715006021 • Yellow
---	--------------------------	---



- Plow blade made from 12-gauge steel.
- Replaceable wear blade.
- Large pin designed for easy blade rotation to eliminate snow buildup at pivot point.
- Blade design provides best snow roll-off at any angle.
- Clears 66" (168 cm) when plow is fully angled.
- Blade height of 17" (43 cm).
- Compatible with Can-Am ProMount Blade accessories to further enhance plow versatility.
- Not compatible with S3 High Clearance Front A-Arm.

CAN-AM ProMount ANGLE PLOWS

Can-Am ProMount 66" (168 cm) Steel Oneway State Blade	Fits ProMount Push Frame	715007263
Can-Am ProMount 72" (183 cm) Steel Oneway State Blade	Fits ProMount Push Frame	715007264



- Make the job easier with the right tools, clear long alleys and make the task easier by sending the snow further out of the way.
- Wing end of plow measures 26" (67 cm) high and tapers down to 16" (41 cm).
- One-way "winged" state plow designed to throw snow higher.
- Rubber flap designed to keep snow away from the driver.
- Can-Am branded.

CAN-AM ProMount FLEX2 PLOW KIT

Can-Am ProMount Flex2 72" (183 cm) Blade	Commander, Commander MAX, Maverick Trail, Maverick Sport, Maverick Sport MAX	715007776
---	--	------------------



- These kits include:
 - Can-Am ProMount Flex2 Blade.
 - Push Frame with Quick-Attach System.
 - Can-Am ProMount Mounting Plate.

CAN-AM ProMount FLEX2 BLADES

Can-Am ProMount Flex2 72" (183 cm) Blade	Fits ProMount Push Frame	715004485
---	--------------------------	------------------



- Plow blade made of UHMWPE, flexible and impact absorbing material prevents damaging your plow when accidental impact occurs.
- Replaceable wear blade.
- Large pin designed for easy blade rotation to eliminate snow buildup at pivot point.
- Blade design provides best snow roll-off at any angle.
- Clears 66" (168 cm) when plow is fully angled.
- Blade height of 17" (43 cm).
- Compatible with Can-Am ProMount Blade accessories to further enhance plow versatility.

CAN-AM ProMount PLOW ACCESSORIES

Can-Am ProMount Edge Markers	Commander, Commander MAX, Maverick Trail, Maverick Sport, Maverick Sport MAX	715004206
-------------------------------------	--	------------------



- Help locate the edges of your plow.
- Height: 24" (60 cm).
- Sold in pairs.
- Recommended for Maverick Trail and Maverick Sport.
- Compatible with Can-Am ProMount Steel and Flex2 blades with or without Blade Extensions (Except for the Can-Am ProMount Steel 54" (137 cm) Blades).

Can-Am ProMount 54" (137 cm) Plastic Wear Blade	Maverick Trail, Maverick Sport, Maverick Sport MAX	715004480
--	--	------------------

Can-Am ProMount 60" (152 cm) Plastic Wear Blade	Maverick Trail, Maverick Sport, Maverick Sport MAX	715004481
--	--	------------------

Can-Am ProMount 66" (168 cm) Plastic Wear Blade	Maverick Trail, Maverick Sport, Maverick Sport MAX	715004482
--	--	------------------

Can-Am ProMount 72" (183 cm) Plastic Wear Blade	Commander, Commander MAX, Maverick Trail, Maverick Sport, Maverick Sport MAX	715004483
--	--	------------------



- Ideal to prevent leaving marks on your driveway.
- Compatible with Can-Am ProMount 72" (183 cm) Blades.

Can-Am ProMount Drift Cutters	Commander, Commander MAX, Maverick Trail, Maverick Sport, Maverick Sport MAX	715006258
--------------------------------------	--	------------------



- Help keep snow in the plow.
- Dimensions: 17" x 13" (43.2 cm x 33 cm).
- Sold in pairs.
- Compatible with Can-Am ProMount Steel and Flex2 blades with or without Blade Extensions (except for the Can-Am ProMount Steel 54" (137 cm) Blades).

Can-Am ProMount Blade Extensions	Commander, Commander MAX, Maverick Trail, Maverick Sport, Maverick Sport MAX	<ul style="list-style-type: none"> 715004205 • Black 715005319 • Yellow
---	--	---



- These conveniently extend your Can-Am ProMount Blade.
- Add 3" (8 cm) each side.
- Compatible with Can-Am ProMount Blades (except for the Can-Am ProMount Steel 54" (137 cm) Blades).
- Longer Wear Blade can be installed to go over the extra length given by the extensions.

Back Drag Blade <i>(Not illustrated)</i>	ProMount Plows (60" and more)	715007794
--	-------------------------------	------------------

- ¼-in. thick steel swivel scraper.
- Lifts up when the vehicle is moving forward so as not to affect the scraping.
- Increased capacity to pull snow.
- More aggressive scraping in reverse mode.
- Lifts the scraper off the ground so that it scrapes evenly.
- Adjustable in length for compatibility with 60", 66" and 72" blades.
- Compatible with ProMount blades (Flex and Steel).

Curved Wear Blade <i>(Not illustrated)</i>	Commander, Commander MAX, Maverick Trail, Maverick Sport, Maverick Sport MAX,	<ul style="list-style-type: none"> 715007791 • 60" (152 cm) 715007792 • 66" (168 cm) 715007793 • 72" (183 cm)
--	---	--

- Wear blade designed with a folded back bottom lip.
- The increased surface allows for less digging while plowing uneven surfaces.
- Ideal for snow covered gravel, grass, paver stone and other soft surfaces.

CAN-AM ProMount CUSTOM SOLUTIONS

<p>Can-Am ProMount Push Frame With Quick-Attach System</p> 	<p>Commander, Commander MAX Maverick Trail, Maverick Sport, Maverick Sport MAX</p>	<p>715007752</p>
<ul style="list-style-type: none"> • Heavy-duty steel tubes designed to withstand the roughest use. • Mid-mount carriage provides ultimate push strength and traction. • Allows 16" (41 cm) of plow lift on ATVs and 14" (36 cm) on Maverick Trail. • Features a self-aligning quick-attach system, an easy foot release pedal and an ergonomic handle for plow angle adjustment. 		

<p>Can-Am ProMount Push Frame Extension</p> 	<p>Commander, Commander MAX, Maverick Trail, Maverick Sport, Maverick Sport MAX</p>	<p>715006257</p>
<ul style="list-style-type: none"> • 12" (30 cm) push frame extension required when plow is installed with Apache Track systems. 		

<p>Plow Roller Fairlead</p> 	<p>Commander, Commander MAX, Maverick Trail, Maverick Sport, Maverick Sport MAX</p>	<p>705203753 • Conical Roller Fairlead 715001223 • Cylindrical Roller Fairlead</p>
<ul style="list-style-type: none"> • Larger diameter lower roller reduces wear on wire rope for plow application. • Can be used with all ProMount plows. 		

<p>Can-Am ProMount Plow Angling System</p> 	<p>Commander, Commander MAX, Maverick Trail, Maverick Sport, Maverick Sport MAX</p>	<p>715007801</p>
<ul style="list-style-type: none"> • Converts your plow system into an easy-to-control unit from the driver's seat. • Using one hand to control all plow motions will allow you to easily concentrate and manage your plowing tasks. • Not compatible with Apache Backcountry LT Track System. • Can-Am ProMount Push Frame (715007752) is required. • Push Frame Extension 715006257 is required for installation with the Front Rancher Bumper. • Winch and plow sold separately. 		

<p>ProMount Plow Limit Switch <i>(Not illustrated)</i></p>	<p>Commander, Commander MAX, Maverick Trail, Maverick Sport, Maverick Sport MAX</p>	<p>715006259</p>
<ul style="list-style-type: none"> • For controlling the cable tension when over-raising your plow system. • Prevents winch, plow push frame and vehicle damage. • Sensor relocated for optimal lift height. 		

<p>Can-Am ProMount Mounting Plate</p> 	<p>Commander, Commander MAX, Maverick Trail, Maverick Sport, Maverick Sport MAX</p>	<p>715007742</p>
<ul style="list-style-type: none"> • Required to install the Can-Am ProMount Push Frame with Quick-Attach System. • Mounting plate precision-designed to stay on year round without compromising ground clearance. • Plow Roller Fairlead included. 		

TRAILERING

<p>Trailer Cover</p> 	<p>Commander Commander MAX Maverick Trail, Maverick Sport Maverick Sport MAX</p>	<p>715006817 715007108 715003706 715005281</p>
<ul style="list-style-type: none"> • Weather-resistant trailering cover protects your vehicle during storage and transportation. • Heavy-duty canvas made of UV-resistant solution-dyed polyester. • Inner soft liner protects windshield. • All high-abrasion areas are reinforced with a double canvas layer. • Opening for fuel cap. • Quick and easy installation. • Designed to perfectly fit your vehicle with or without Can-Am accessories except with Adventure Roof Rack and track kits. 		

TIRES & RIMS

TIRES - COMMANDER

<p>XPS Trail Force Tire</p> 	<p>Commander DPS</p>	<p>705402754 • Front 705503103 • Rear</p>
<ul style="list-style-type: none"> • All-terrain radial tire. • 8-ply construction offered in: Front 27X9R14 & Rear 27X11R14. • Versatile and suitable for many types of terrain. • Aggressive tread pattern for better traction on dirt, mud and rocky terrains. • Tread depth: 20 mm. • Max PSI: 42. 		

<p>XPS Trail King Tire</p> 	<p>Commander XT</p>	<p>705402825 • Front 705503181 • Rear</p>
<ul style="list-style-type: none"> • Radial tire. • 6-ply construction offered in: Front 28X9R14 & Rear 28X11R14. • Aggressive tread pattern for tougher terrains. • An almost continuous center tread offers a smoother trail ride. • Tread depth: 26 mm. • Max PSI: 42. 		

<p>XPS Hammer Force Tire</p> 	<p>Commander XT-P</p>	<p>705402918 • Front & Rear</p>
<ul style="list-style-type: none"> • Light truck-inspired tire. • 8-ply construction offered in 30X10R15. • Rock-crawling tread pattern with unique contact patch. • Aggressive sidewall for maximum traction when faced with technical terrains. • Tread depth: 15 mm. • Max PSI: 44. 		

<p>Maxxis Coronado Tire</p> 	<p>Commander, Commander MAX†</p>	<p>705402058 • Front 705502576 • Rear</p>
<ul style="list-style-type: none"> • Front: 27" x 9" x 14". • Rear: 27" x 11" x 14". • Compliant with European class T regulations. <p>†Except XT-P.</p>		

TIRES - MAVERICK TRAIL & MAVERICK SPORT

Maxxis Bighorn 2.0 Tire	Maverick Sport, Maverick Sport MAX	705402560 • Front
		705502938 • Rear



- Front · 27" x 9" x 12".
- Rear · 27" x 11" x 12".
- Compliant with European class T regulations.

Maxxis Liberty Tire	Maverick Sport X rc	705402401 • Front
		705402143 • Rear



- Engineered for performance driving and to give you and your side-by-side freedom in a variety of terrains.
- Exceeds DOT test standards.
- 8-ply radial construction.
- Specialized rubber compound for supreme traction and control.
- Excellent tread wear.
- Front: 28" x 10" x 14".
- Rear: 30" x 10" x 14".

Carlisle ACT Tire	Maverick Trail	705402313 • Front
		705402314 • Rear



- Front · 26" x 8" x 12".
- Rear · 26" x 9" x 12".

RIMS

12" Maverick Trail DPS/Sport Rim	Maverick Trail DPS	705401417 • Front
	Maverick Sport	705501853 • Rear
	Maverick Sport	705401417 • Rear
	Maverick Trail DPS	705401417 • Rear



- Matching Nuts: 250100184 (Black).
- Matching Cap: 705400928.
- Maverick Sport: Front · 12" x 6" Offset = 41mm/Rear · 12" x 7.5" Offset = 51mm.
- Maverick Trail DPS: Front · 12" x 6" Offset = 41mm/Rear · 12" x 6" Offset = 41mm.

14" Maverick Sport X rc/X mr Rim	Maverick Sport X rc/X mr	705402338 • Front
	Maverick Sport X rc	705402338 • Rear
	Maverick Sport X mr	705502778 • Rear



- Maverick Sport X rc: Front · 14" x 7" Offset = 41mm/Rear · 14" x 7" Offset = 41mm.
- Maverick Sport X mr: Front · 14" x 7" Offset = 41mm/Rear · 14" x 8.5" Offset = 51mm.

12" Maverick Trail Rim	Maverick Trail	705401217
-------------------------------	----------------	------------------



- Matching Nuts: 250100042.
- 12" x 6" – Offset = 41 mm.

EXPLORE AN ENTIRE WORLD OF ADVENTURE WITH ALL OF OUR BRP PRODUCTS. BRP.COM



ski-doo LYNX SEA-DOO CAN-AM ROTAX ALUMACRAFT Manitou QUINTREX



CAN-AMOFFROAD.COM

