

PUSHING LIMITS
ADRENALINE
CHALLENGES
FAMILY MUD
PERFORMANCE
WE'RE FARMING
BUILT HUNTING
FOR ADVENTURE
THIS HARD WORK

**WE'RE
BUILT
FOR
THIS**



TRAXTER



2019 ACCESSORIES, RIDING GEAR & GENUINE PARTS
EUROPE, MIDDLE EAST AND AFRICA VERSION

CAN-AM ACCESSORIES: THE PERFECT FIT

ENHANCE & EXTEND YOUR OFF-ROAD EXPERIENCE WITH ACCESSORIES BUILT BY CAN-AM FOR CAN-AM.

Wherever you're going, and whatever you're doing, Can-Am Off-Road accessories can help get you there and get it done – faster and more efficiently. High-quality, innovative accessories that work right, fit right and feel right because they're developed or approved by Can-Am for Can-Am.

QUALITY FIRST.

The best off-road accessories are here for a reason: you. High-performance engineering and hard-fought lessons drive the design of everything we do—from our vehicles to the oil they run on.

RUGGED RELIABILITY.

Why do we guarantee Genuine Can-Am accessories for an entire year? Because we can. Install them yourself or at an authorized dealer and immediately upgrade your off-road vehicle without worry.

STYLE & VISION.

Our designers work on both vehicles and accessories, meaning our accessories lineup performs perfectly and looks as great as the Can-Am's they've been designed for.

BRP LIMITED WARRANTY*

FOR NEW PARTS, ACCESSORIES AND RIDING GEAR.

2 YEARS LIMITED WARRANTY**

- GENUINE CAN-AM PARTS & ACCESSORIES INSTALLED BY YOU OR YOUR AUTHORIZED BRP DEALER
- CO-BRANDED PRODUCTS SOLD THROUGH BRP¹
- RIDING GEAR

4 YEARS LIMITED WARRANTY**

- HELMETS

*Use other than which the product is designed for will void the product lifetime warranty. *Applies only to BRP-made products or co-branded products made by accredited BRP partners (Lonestar Racing for Can-Am, DragonFire for Can-Am, S3 for Can-Am, Beard Seats for Can-Am, Baja Designs for Can-Am, etc.). Purchased at an authorized BRP dealership / distributor or on a BRP-authorized online store. Other exclusions may apply, see complete limited warranty or contact your Can-Am off-road authorized dealer. †Includes only BRP-approved aftermarket products and products made by currently accredited BRP partners. **Unless otherwise stipulated or required by law. This limited warranty does not apply to factory installed accessories. This limited warranty does not apply on Evinrude parts and accessories. This limited warranty is effective as of March 1st, 2016.

© 2018 Bombardier Recreational Products Inc. (BRP). All rights reserved. ®, ™ and the BRP logo are trademarks of BRP or its affiliates. CARLISLE is a trademark of Carlisle Companies. CHAMUDE and HIPORA are registered trademarks of Kolon Industries, Inc. CLARINO is a trademark of Kuraray Co. Ltd. COOLMAX and THERMOLITE are registered trademarks of INVISTA for durable fabrics. DRIFRELEASE is a registered trademark of Optimer Inc. FOX is a registered trademark of Fox Racing Canada. GARMIN and MONTANA are registered trademarks of Garmin Ltd. iPod is a registered trademark of Apple Inc. KOLPIN, GUN BOOT and IMPACT are registered trademarks of Kolpin Powersports Inc. KYB is a registered trademark of Kayaba. microSD is a registered trademark of SD Card Association. Mud Lite XTR and SS312 are trademarks of TIP Tires. NEXT G-1 VISTA is a trademark of Next Camo, LLC. NGK is a registered trademark of NGK Spark Plugs, Ltd. PRIMALOFT GOLD and PRIMALOFT BLACK are registered trademarks of Albany International Corp. SUPERWINCH and S SUPERWINCH (design) are registered trademarks of Superwinch LLC. TEFLON, TEFLON HT and KEVLAR are trademarks of E.I. DuPont de Nemours & Co. TWINAIR is a trademark of Twin Air USA. UNI is a trademark of UNIFILTER Inc. VELCRO is a registered trademark of Velcro Industries. WARN is a trademark of Warn Industries Inc. YUASA is a registered trademark of YUASA Batteries Inc. ZILLA and BIGHORN 2.0 are trademarks of Maxxis. SCOTT is a trademark of Scott Sports SA. The following trademarks are the property of their respective owners: BLUETOOTH, CREE, DURO, DWT, HELLA, ITP, KENDA, MOSSY OAK, RAM, SUR LAST, VISION, XPS and YOSHIMURA. DRAGONFIRE is a trademark of KRANSCO. Baja Designs is a registered trademark of Baja Designs Inc. S3 POWERSPORTS is a trademark of S3 Power Sports LLC. Some models depicted herein may include optional equipment. Prices, if shown, are based on Manufacturer Suggested Retail Prices. Dealers may sell for a different price. For Canada & US, taxes are not included. Depending on location, products are distributed by BRP US Inc., Bombardier Recreational Products Inc., BRP European Distribution SA, BRP Finland Oy., BRP Australia Pty Ltd. or BRP Brasil Motorsports LTDA. BRP reserves the right, at any time, to discontinue or change specifications, prices, designs, features, equipment without incurring obligation.

¹Warranty periods may vary per region.



ACCESSORIES

7	ROOFS	41	LIGHTS
9	HARD CABS	44	AUDIO & COMMUNICATION SYSTEMS
10	SOFT CABS		
11	WINDSHIELDS & MIRRORS	45	ELECTRICAL & ELECTRONIC ACCESSORIES
14	DOORS		
16	REAR WIND PROTECTION	49	WINCHES & HITCHES
18	SKID PLATES	52	SEATS
19	BUMPERS & GUARDS	53	PERFORMANCE
29	CARGO & STORAGE	56	TRACK SYSTEM
38	RACKS & HOLDERS	57	PLOWS
		59	COVERS & ADD-ONS

TIRES & RIMS

59	TIRES	61	RIMS
----	-------	----	------

SPORTSWEAR & RIDING GEAR

62	CAN-AM SPORTSWEAR	70	HELMETS
65	JERSEYS	71	DUST MASKS
66	MUD GEAR	71	COMMUNICATION SYSTEM
66	JACKETS & PANTS	72	GOGGLES
69	BOOTS	73	GLOVES
69	BALACLAVAS	74	JUNIOR
69	NECK AND BODY CORE PROTECTION	74	BAGS
		75	SIZING CHART

PARTS & MAINTENANCE

76	GENUINE CAN-AM PARTS
82	OILS & MAINTENANCE



GOING GLOBAL

This catalog, global in nature, shares BRP's full parts, accessories and clothing product offering. Some products may not be available in your country, due to different climates, local certifications and/or legal requirements. Contact your BRP dealer for local specifics.

CAN-AMOFFROAD.COM



Explore our interactive online catalog. Instantly explore products, videos, large format images and share with friends!



Check out our videos to learn more about our new innovative riding gear and accessories.



Learn about and purchase XPS oils and lubricants.

Visit instructions.brp.com for BRP accessories instruction sheets.

You will find complete installation instructions, part number lists and service kits for repair and maintenance.

WE'RE BUILT FOR HARD WORK

JOB AND JOURNEYS ARE EASIER WHEN SOMEONE'S GOT YOUR BACK: WE ENGINEER UTILITY UPGRADES TO WORK SEAMLESSLY AND TIRELESSLY WITH YOUR TRAXTER.



TRAXTER

- 11 FLIP GLASS WINDSHIELD
- 14 HALF DOORS
- 16 REAR GLASS WINDOW WITH SLIDING PANEL
- 19 FRONT CORNER PROTECTORS
- 19 FRONT BUMPER
- 20 FRONT BODY SIDE PROTECTORS
- 22 REAR BUMPER
- 22 REAR BODY SIDE PROTECTORS
- 23 MUD FLAPS
- 23 ROCK SLIDERS
- 29 HEADACHE RACK
- 33 LinQ CARGO RACK
- 41 4" (10 CM) ROUND LED LIGHTS (2 X 25 WATTS)

WE'RE BUILT FOR MUD

DEEP THRILLS AHEAD: WHEN RUNNING THROUGH THE THICK OF IT JUST TO PUT A SMILE ON YOUR FACE, S3'S LINEUP OF PROVEN UPGRADES GIVES THE CONFIDENCE AND CONTROL TO HAVE YOU CRAVING MUD.



TRAXTER

S3
FOR *can-am*

- 7 SPORT ROOF
- 13 HALF WINDSHIELD
- 18 ALUMINIUM SKID PLATE KIT
- 22 FENDER FLARES
- 24 S3 FRONT WINCH BUMPER
- 25 S3 REAR WINCH BUMPER
- 25 S3 NERF BARS
- 34 CARGO BED RAILS
- 41 15" (38 CM) DOUBLE STACKED LED LIGHT BAR (90 WATTS)
- 43 LIGHT RACK
- 53 S3 HIGH CLEARANCE A-ARM FRONT & REAR
- 54 SNORKEL KIT
- 54 SNORKEL EXTENSIONS



WE'RE BUILT FOR PLAY

STANDING OUT & GETTING THE MOST FROM THE TRAXTER IS A STEP CLOSER WITH DRAGONFIRE'S ARRAY OF PROTECTION BARS, ENGINEERED FOR RECREATION AND TO PERFORM, FIT, AND LOOK LIKE NOTHING ELSE.



TRAXTER



- 13 HALF WINDSHIELD
- 13 SIDE MIRROR
- 14 HALF DOORS
- 26 DRAGONFIRE FRONT BUMPER
- 26 DRAGONFIRE FRONT EXO-FRAME
- 27 DRAGONFIRE SPARE TIRE HOLDER
- 27 DRAGONFIRE SIDE RUNNERS
- 27 DRAGONFIRE REAR BUMPER
- 27 DRAGONFIRE REAR EXO-FRAME
- 28 DRAGONFIRE CARGO BED ROLL
- 29 ADVENTURE ROOF RACK
- 41 4" (10 CM) ROUND LED LIGHTS (2 X 25 WATTS)



WE'RE BUILT FOR HUNTING

YOUR ULTIMATE HUNTING RIG IS WITHIN REACH—IT'S JUST A MATTER OF OUTFITTING IT TO YOUR NEEDS. THE TRAXTER ADAPTS QUICKLY BETWEEN JOB AND WEEKEND USE, AND MAKES SHORT WORK OF BRINGING GAME HOME.



TRAXTER

- 7 SPORT ROOF
- 11 FLIP GLASS WINDSHIELD WITH WIPER & WASHER KIT
- 16 REAR GLASS WINDOW
- 34 CARGO BED RAIL
- 38 STRONGHOLD GUNBOOT IMPACT BY KOLPIN
- 38 GEAR RAIL FOR STRONGHOLD
- 38 STRONGHOLD AUTO-LATCH MOUNT BY KOLPIN
- 39 GEAR RAIL ADAPTOR
- 43 RAM LED SPOTLIGHT

THE BEST FROM OUR PARTNERS



S3
FOR *can-am*

S3 HAS THE EDGE WHEN IT COMES TO **MUD MASTERING** ACCESSORIES—BUMPER THAT FIT TRAXTER PERFECTLY FOR WORK AND PLAY, WHILE INTEGRATING A WINCH MOUNT FOR WHEN THE WORLD BITES BACK.



DragonFire
FOR *can-am*

TRAIL-TOUGH STRENGTH DOESN'T HAVE TO SACRIFICE SHARP LINES. DRAGONFIRE ACCESSORIES ARE DESIGNED TO MATCH THE VEHICLE'S BODY AND GREATLY ENHANCE ITS OVERALL LOOK.



SCS
UNLIMITED

SCS WRAP KITS—PERFECTLY-SIZED AND **EXCLUSIVE WRAP DESIGNS** THAT WILL COMPLEMENT YOUR TRAXTER AND REFRESH ITS LOOK. YOU'RE UNIQUE. YOUR RIDE SHOULD BE TOO.

Available at participating Can-Am dealers and scscanamgraphics.com



SCS wraps are of the highest quality, made with 0.004" engineering-grade vinyl overlaid with a 0.008" UV-protective laminate. That means vibrant colors, easy installation and a wrap that will hold up to the rigors of the off-road. SCS can even customize the color combinations; adding names, numbers and logos according to your exact specifications. Available for both 2-seat and 4-seat Traxter models.



OUR DELUXE SPORT ROOF PROVIDES EXCELLENT PROTECTION WITH PERFECT FIT & FINISH

SPORT ROOF

- Robust injection-molded polypropylene construction.
- Provides added protection for rider and passenger from the elements.

Traxter
715002430
\$XXXX

Traxter MAX
715003038
\$XXXX



DELUXE SPORT ROOF

- Complete roof kit provides extra driver and passenger protection and also diminishes noise within the cab.
- Perfect fit and finish thanks to the seal kit and the liners included.

Traxter
Kit includes:
• Sport Roof (715002430)
• Sport Roof Seal Kit (715003126)
• Front Roof Liner (715003098)
• Rear Roof Liner (715003099)
715002511
\$XXXX

Traxter MAX
Kit includes:
• Sport Roof (715003038)
• Sport Roof Seal Kit (715003583)
• Front Roof Liner (715003098)
• Rear Roof Liner (715003582)
715003039
\$XXXX

SPORT ROOF SEAL KIT

- (Not illustrated)
- Necessary when installing individual cab components with Sport Roof or when installing the front and rear Roof Liners.

Traxter
715003126
\$XXXX

Traxter MAX
715003583
\$XXXX

Some products shown may not be available or homologated in your country. Contact your BRP dealer for local details.



ALL-WEATHER, ANYTIME:
TOUGH ALL-IN-ONE CAN-AM
ENCLOSURES GIVE
UNMATCHED PROTECTION

BIMINI ROOF WITH SUN VISOR

- Heavy-duty canvas made of UV-resistant solution-dyed polyester.
- Innovative soft top comes with a hard visor that allows for storage of rolled-up soft top and mounting of Light Rack.
- Quick and easy installation.
- Not compatible with soft and rigid doors.

Traxter MAX

715003030 - Black

\$XXXX

715003469 - Mossy Oak Break-Up Country Camo

\$XXXX



BIMINI ROOF WITH SUN VISOR

- Heavy-duty canvas made of UV-resistant solution-dyed polyester.
- Innovative soft top comes with a hard visor that allows for storage of rolled-up soft top and mounting of Light Rack.
- Quick and easy installation.

Traxter

• Not compatible for use with soft and rigid full doors.

715003418 - Black

\$XXXX

715002849 - Mossy Oak Break-Up Country Camo

\$XXXX



DELUXE XT RIGID CAB ENCLOSURE

- Rigid cab enclosure ideal for Traxter XT vehicles that come stock with a roof, but also fits on Base and DPS models with the addition of a roof.
- Offers good driver and passenger protection from the elements.
- Not EC compliant.

Included:

- Flip Glass Windshield (715002942)
- Rear Polycarbonate Window (715002922)
- Full Doors with Power Windows (715001968)
- Wiper and Power Windows Cable (710004462)
- Power Cable (715003094)
- Sport Roof Seal Kit (715003126)

Traxter

715003482

\$XXXX



NEW PREMIUM RIGID CAB ENCLOSURE

- Provides driver and passenger with the best protection from the elements and the cold, and features the most complete top-of-the-line accessories our product lineup has to offer.
- Not EC compliant.

Included:

- Sport Roof (715003038)
- Sport Roof Seal Kit (715003583)
- Front Roof Liner (715003098)
- Rear Roof Liner (715003582)
- Flip Glass Windshield with Wiper and Washer Kit (715002441)
- Full Doors with Power Windows (715001968)
- Rear Full Doors (715003036)
- Rear Glass Window with Sliding Panel (715002440)
- Wiper and Power Windows Cable (710004462)
- Power Cable (715003094)

Traxter MAX

715003037

\$XXXX



Included:

- Deluxe Sport Roof (715002511)
- Flip Glass Windshield with Wiper and Washer Kit (715002441)
- Full Doors with Power Windows (715001968)
- Rear Glass Window with Sliding Panel (715002440)
- Wiper and Power Windows Cable (710004462)
- Power Cable (715003094)

Traxter

715001966

\$XXXX

FRONT ROOF LINER

- Vehicle enhancement.
- Integrates seamlessly with roof-mounted light switch.
- Must be used for light installation on the roof.
- Must be used for radio and allows a better integration of Windshield Wiper and Washer Kit (715001638).
- Seal Kit necessary when installing with Sport Roof (715003038 or 715002430).

Traxter, Traxter MAX

715003098

\$XXXX



REAR ROOF LINER

- Quick and easy vehicle enhancement.
- Allows better integration of other accessories installed on the roof.

Traxter

Needs to be installed with Sport Roof (715002430). Seal Kit (715003126) necessary when installing with Sport Roof.

715003099

\$XXXX

Traxter MAX

(Not illustrated) Needs to be installed with Sport Roof (715003038). Seal Kit (715003583) necessary when installing with Sport Roof.

715003582

\$XXXX

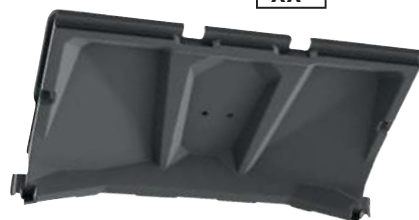

DESIGN YOUR OWN CAB. Pick the accessories of your choice and **build** or **complete** your own cab.

100% MODULAR COMPONENTS DESIGNED TO WORK TOGETHER: **ROOFS P.7 WINDSHIELDS P.11 DOORS P.14 REAR WINDOWS P.16**

Some products shown may not be available or homologated in your country. Contact your BRP dealer for local details.



GET MORE OUT OF YOUR TRAXTER WITH A COMPLETE SOFT CAB ENCLOSURE, OR PICK THE ACCESSORIES OF YOUR CHOICE

SOFT CAB ENCLOSURE

• Protection for rider and passenger from the elements.

Included:

- Bimini Roof with Sun Visor (715002918 - not sold separately / 715003030)
- Full Windshield - Hardcoated (715002432)
- Soft Doors (715002919 / 715003033)
- Soft Rear Panel (715002920)

Traxter

715002917 • Black

\$XXXX

Traxter MAX

715003032 • Black

\$XXXX

Included:

- Bimini Roof with Sun Visor (715002849 / 715003469)
- Full Windshield - Hardcoated (715002432)
- Soft Doors (715003402 / 715003470)
- Soft Rear Panel (715003403)

Traxter

715003401 • Mossy Oak Break-Up Country Camo

\$XXXX

Traxter MAX

715003468 • Mossy Oak Break-Up Country Camo

\$XXXX



DESIGN YOUR OWN CAB. Pick the accessories of your choice and **build** or **complete** your own cab.

100% MODULAR COMPONENTS DESIGNED TO WORK TOGETHER: **ROOFS** P.7 **WINDSHIELDS** P.11 **DOORS** P.14 **REAR WINDOWS** P.16

Some products shown may not be available or homologated in your country. Contact your BRP dealer for local details.

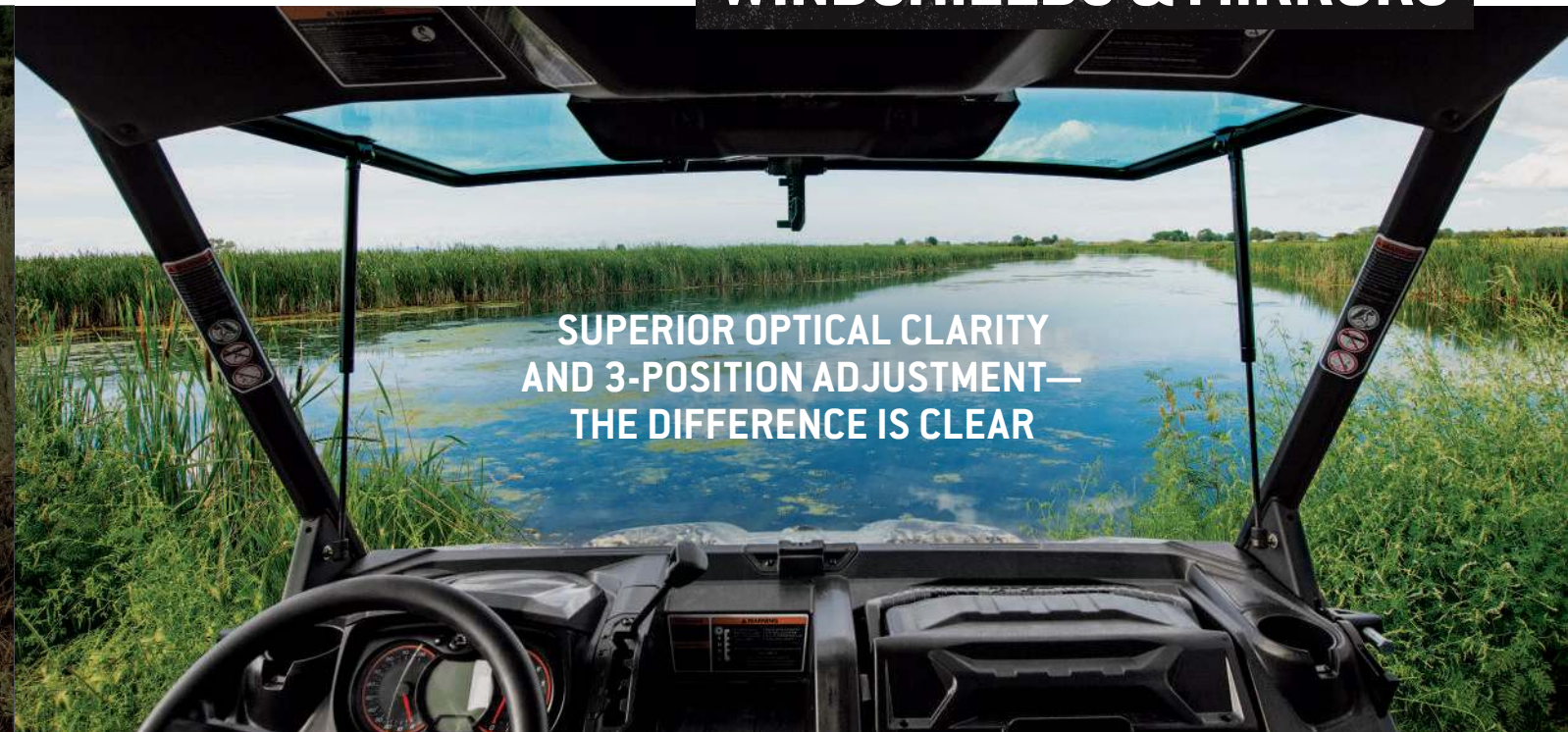

SUPERIOR OPTICAL CLARITY AND 3-POSITION ADJUSTMENT—THE DIFFERENCE IS CLEAR

FLIP GLASS WINDSHIELD

- Curved and laminated glass full windshield in metal frame.
- Provides excellent optical clarity.
- Seals firmly against the cage and protects rider and passenger from the elements while allowing for controlled air flow.
- 3-position flip can be set at fully closed, ¼ open, or fully open.
- Gas-shock-assisted operation and pivots on 2 hinges located at the top of the windshield.
- Ideal for muddy conditions.
- Can be used with Windshield Wiper and Washer Kit (715001638).
- Not EC compliant.

Traxter, Traxter MAX

715002942

\$XXXX

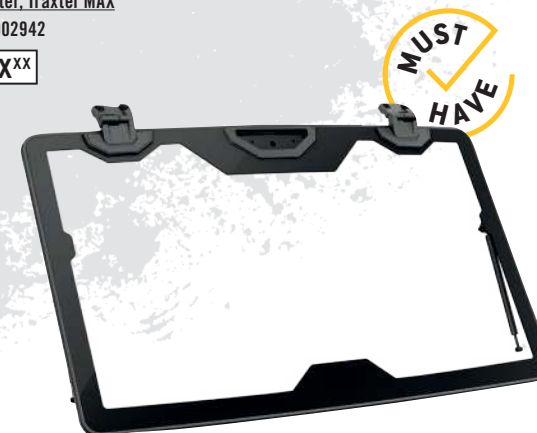

MUST HAVE

FLIP GLASS WINDSHIELD WITH WIPER & WASHER KIT

- Curved and laminated glass full windshield in metal frame.
- Provides excellent optical clarity.
- Seals firmly against the cage and protects rider and passenger from the elements while allowing for controlled air flow.
- Flip windshield can be set fully closed or fully open according to your preference.

Traxter, Traxter MAX

715002441

\$XXXX



ALL OF THE ADVANTAGES OF OUR FLIP GLASS WINDSHIELD WITH ADDED WIPER/WASHER VERSATILITY.

WINDSHIELD WIPER AND WASHER KIT

- An ideal way to keep your windshield clear in rain, or while riding through mud and water.
- Includes single-speed wiper, washer fluid dispenser and windshield frame mount.
- Must be used with the Glass Windshield (715001303) or Flip Glass Windshield (715002942).
- Requires Wiper and Power Windows Cable (710004462) and Power Cable (715003094).
- Not EC compliant.

Traxter, Traxter MAX

715001638

\$XXXX



WIPER AND POWER WINDOWS CABLE

- (Not illustrated)
- Required to install Full Doors with Power Windows (715001968) and/or Windshield Wiper and Washer Kit (715001638).
- Necessary if you want to build your own cab enclosure from modular components.

Traxter, Traxter MAX

710004462

\$XXXX



FLIP WINDSHIELD - HARDCOATED

- High-impact-resistant Makrolon® hardcoated polycarbonate full windshield in metal frame.
- Provides excellent optical clarity and better abrasion resistance.
- Seals firmly against the cage and protects rider and passenger from the elements while allowing for controlled air flow.
- 3-position flip can be set at fully closed, ¼ open, or fully open.
- Gas-shock-assisted operation.
- Ideal for muddy conditions.

Traxter, Traxter MAX

715002442

\$XXX^{XX}



GLASS WINDSHIELD

- Curved and laminated glass full windshield in metal frame.
- Seals firmly against the cage and protects rider and passenger from the elements while providing excellent optical clarity.
- Must be used with Windshield Wiper and Washer Kit (715001638) to maintain clear visibility during severe riding conditions.
- Not EC compliant.

Traxter, Traxter MAX

715001303

\$XXX^{XX}



FULL WINDSHIELD - HARDCOATED

- High-impact-resistant Makrolon® ultra resistant polycarbonate full windshield.
- Provides excellent optical clarity and better abrasion resistance.
- Protects driver and passenger from the elements.
- Quick and easy tool-less installation or removal.

Traxter, Traxter MAX

715002432

\$XXX^{XX}



FULL WINDSHIELD

- High-impact-resistant durable polycarbonate full windshield.
- Formulated to be non-yellowing, non-crazing, non-cracking with excellent UV resistance and optical clarity.
- Protects driver and passenger from the elements.
- Quick and easy tool-less installation or removal.

Traxter, Traxter MAX

715002431

\$XXX^{XX}



HALF WINDSHIELD

- High-impact-resistant durable polycarbonate half-windshield.
- Formulated to be non-yellowing, non-crazing, non-cracking with excellent UV resistance and optical clarity.
- Protects driver and passenger from the elements.
- Features reverse angle lip to deflect air flow.
- Quick and easy tool-less installation or removal.
- Not compatible with Soft Doors.

Traxter, Traxter MAX

715002433

\$XXX^{XX}



SIDE MIRROR

- Molded heavy-duty aluminum mirror.
- Stays in place on rough trails.
- Ball-joint design for steady multi-angle adjustment and outstanding vision.
- Use with or without roof, windshield or half doors.
- Not for road use.
- Fits either side.
- Sold individually.
- Can be used with or without any roof, windshield or door.

Traxter, Traxter MAX

715002459

\$XXX^{XX}



PANORAMIC CENTER MIRROR

- Wide-angle convex mirror.
- Offers enhanced visibility.
- Can be used with or without roof or windshield.
- Can be used with cab enclosure.

Traxter, Traxter MAX

715003638

\$XXX^{XX}

Some products shown may not be available or homologated in your country. Contact your BRP dealer for local details.



PERFECT-FIT REINFORCED HALF DOORS FOR THE FREEDOM TO TRAVEL OUT TO VISTAS LIKE THIS



EASY TO TAKE OFF WHEN THE TEMPERATURE GOES UP

FULL DOORS WITH POWER WINDOWS

- Made from robust high-density polyethylene.
- Offer excellent protection from the elements.
- Easy to remove on hot and sunny days.
- Lockable doors with convenient integrated storage areas.
- Doors' curved-design provides even more roominess.
- Power window delivers added ventilation.
- Rear hinge wide opening for ease of ingress/egress in the cockpit.
- Compatible with all BRP windshields.
- Require Wiper and Power Windows Cable (710004462) and Power Cable (715003094).
- Sport Roof Seal Kit (715003126) is required.
- Not EC compliant.

Traxter
715001968

\$XXXX



NEW REAR FULL DOORS

- Made from robust high-density polyethylene.
- Offer excellent protection from the elements.
- Easy to remove on hot and sunny days.
- Lockable doors with convenient integrated storage areas.
- Doors' curved-design provides even more roominess.
- Rear hinge wide opening for ease of ingress/egress in the cockpit.
- Pop-out window delivers added ventilation.
- Require Front Doors (715001968), Wiper and Power Windows Cable (710004462), Power Cable (715003094) and Sport Roof Seal Kit (715003583).
- Not EC compliant.

Traxter MAX
715003036

\$XXXX



HALF DOORS

- Half doors made of plastic.
- Metal frame for a higher level of fit and finish and rigidity.
- Rear hinge wide opening for ease of ingress/egress in the cockpit.
- Interior pockets and liners for more protection.

Traxter
(2 doors)
715003029

\$XXXX

Traxter MAX
(4 doors)
715003031

\$XXXX



SOFT DOORS

- Weather-resistant soft doors reinforced with steel frame offer good protection from the elements.
- Made of heavy-duty UV-resistant solution-dyed polyester canvas for excellent resistance to tear and abrasion.
- Rear hinge wide opening for ease of ingress/egress.
- Zip-down windows made of laminated polished vinyl material for added ventilation.
- Quick and easy installation, and easily removable on hot sunny days.
- Compatible with BRP roofs and mirrors.

Traxter (2 doors)
715002919 - Black

\$XXXX

715003402 - Mossy Oak Break-Up Country Camo

\$XXXX

Traxter MAX (4 doors)
715003033 - Black

\$XXXX

715003470 - Mossy Oak Break-Up Country Camo

\$XXXX



Some products shown may not be available or homologated in your country. Contact your BRP dealer for local details.



REAR GLASS WINDOW WITH SLIDING PANEL

- Made of high-strength tempered glass.
- Ideal for preventing backdraft of dust or rain in harsh environments.
- Sliding panel for enhanced ventilation.
- Quick and easy tool-less installation.
- Sport Roof (715002430 or 715003038) required for installation.
- Not EC compliant.

Traxter, Traxter MAX
715002440

\$XXX



REAR GLASS WINDOW

- Made of high-strength tempered glass.
- Ideal for preventing backdraft of dust or rain in harsh environments.
- Quick and easy tool-less installation.
- Sport Roof (715002430 or 715003038) required for installation.
- Not EC compliant.

Traxter, Traxter MAX
715003009

\$XXX



REAR POLYCARBONATE WINDOW

- High-impact-resistant polycarbonate window.
- Ideal for preventing backdraft of dust or rain in harsh environments.
- Quick and easy tool-less installation.
- Sport Roof (715002430 or 715003038) required for installation.

Traxter, Traxter MAX
715002922

\$XXX



REAR WIND SCREEN

- Full rear mesh screen reduces windshield backdraft for added cabin comfort.
- Installs quick and easily on roll cage.
- White Can-Am logo at top, to help maintain clear view.

Traxter, Traxter MAX
715002851

\$XXX



SOFT REAR WINDOW

- Clear, flexible window made of see-through vinyl.
- Resists cold cracking to -4°F (-20°C).
- Blocks windshield backdraft or dust and rain from entering, for added cabin comfort.
- Installs quick and easily on roll cage.
- White Can-Am logo at top, to help maintain clear view.

Traxter, Traxter MAX
715003249

\$XXX



SOFT REAR PANEL

- Weather-resistant soft rear panel with steel frame offers good protection from the elements.
- Made of heavy-duty UV-resistant solution-dyed polyester canvas for excellent resistance to tear and abrasion.
- Tinted window made of laminated polished vinyl material.
- Resists cold cracking to -22 °F (-30 °C).
- Installs quick and easily on roll cage.
- Not compatible with the Bimini Roof with Sun Visor that is sold individually.

Fits: Traxter, Traxter MAX
715002920 - Black

\$XXX

715003403 - Mossy Oak Break-Up Country Camo

\$XXX



BLOCKS WINDSHIELD BACKDRAFT OR DUST AND RAIN FROM ENTERING, FOR ADDED CABIN COMFORT

Some products shown may not be available or homologated in your country. Contact your BRP dealer for local details.

ALUMINUM SKID PLATES

For ultimate durability and strength, all our Aluminum Skid Plates are made with High Strength 5052 H32 Aluminum 3/16" [4.5 mm] thick.

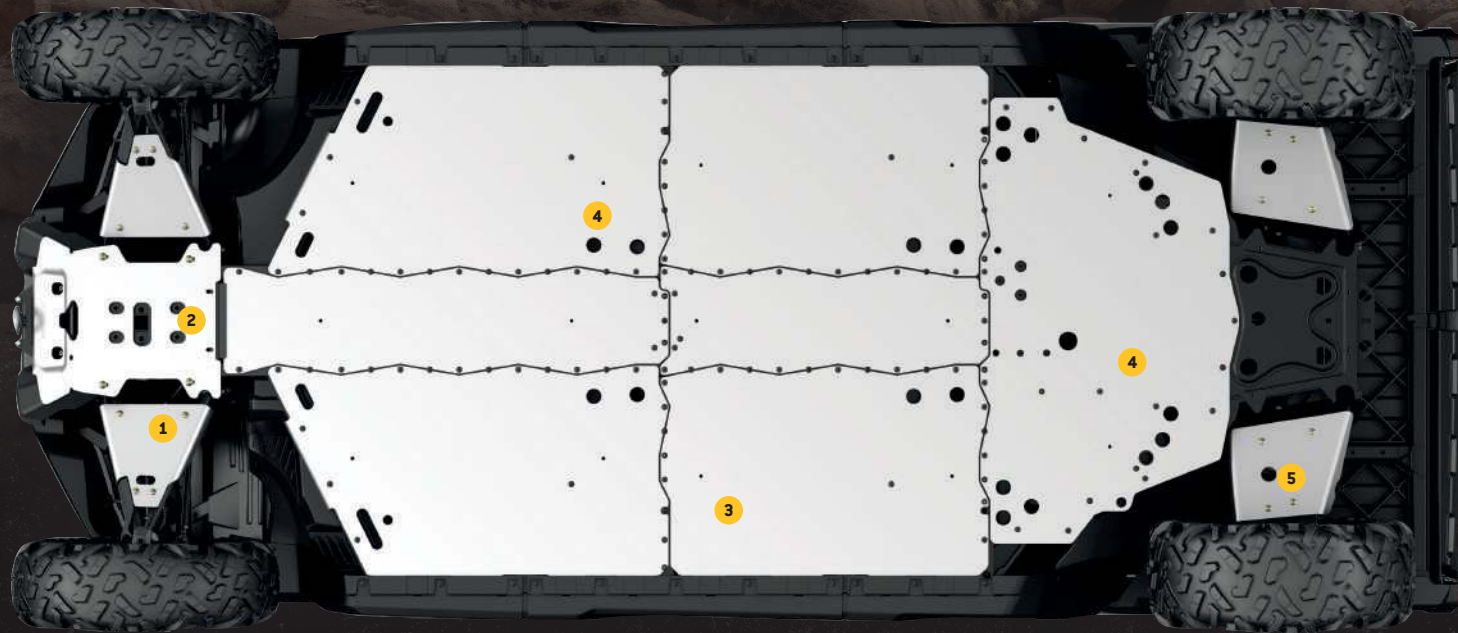

OFFER YOUR TRAXTER THE FULL PROTECTION KIT OR GET THEM INDIVIDUALLY

FIND YOUR MODEL YEAR AND PLATFORM

	TRAXTER	TRAXTER MAX
ALUMINUM SKID PLATE PROTECTION KIT	715003711 \$XXXX	715003712 \$XXXX
INDIVIDUAL ALUMINUM SKID PLATES		
1 FRONT A-ARM PROTECTORS • Extra underside protection for your vehicle's steering mechanism and suspension (A-Arm). • Sold in pairs.	715002444 (except X mr & XT Cab models) \$XXXX	715002444 (except XT Cab models) \$XXXX
2 FRONT SKID PLATE • Protects the front underside of your vehicle when riding in rough terrain conditions. • Adds style to the front of your vehicle.	715002447 \$XXXX	715002447 \$XXXX
3 CENTRAL SKID PLATE • Central skid plate kit includes central and lateral skid plates. • Must be used with Underbelly Skid Plate Kit (715002446). • Ultra-durable protection for the underside of your vehicle. • For MAX models only. • Makes work easy in more demanding terrain.	—	715003467 \$XXXX
4 UNDERBELLY SKID PLATE KIT • Ultra-durable protection for the underside of your vehicle. • Makes work easy in more demanding terrain. • Kit includes lateral and rear skid plates.	715002446 \$XXXX	715002446 \$XXXX
5 REAR A-ARM PROTECTORS • Extra underside protection for your vehicle's suspension (A-Arm). • Sold in pairs.	715002445 (except X mr & XT Cab models) \$XXXX	715002445 (except XT Cab models) \$XXXX

Some products shown may not be available or homologated in your country. Contact your BRP dealer for local details.



ARMOR HAS NEVER LOOKED SO GOOD: XTREME UPGRADES ARE FORMED FROM HIGH-STRENGTH STEEL AND FINISHED TO LAST

FRONT BUMPER

- Heavy-duty 1.5" (3.8 cm) diameter steel-tube construction.
- Provides enhanced protection.
- Inside and outside anti-corrosion coating with durable powder coat finish.
- Light-kit compatible.
- Required to install the Xtreme Front Bumper Plates (715003005) and the Front Corner Protectors (715002833).

Traxter, Traxter MAX
715002418

\$XXXX

XTREME FRONT BUMPER PLATES

- Made of high-strength heavy-gauge steel with rubber pads for increased protection.
- Inside and outside anti-corrosion coating with durable powder coat finish.
- Provide additional front-end protection.
- Require Front Bumper (715002418) for installation.
- Not compliant with T-category vehicles.

Traxter, Traxter MAX
715003005

\$XXXX

FRONT CORNER PROTECTORS

- Heavy-duty 1.25" (3.2 cm) diameter steel-tube construction.
- Provide enhanced protection for front corners.
- Inside and outside anti-corrosion coating with durable powder coat finish.
- Require Front Bumper (715002418) for installation.
- Sold in pairs.

Traxter, Traxter MAX
715002833

\$XXXX





FRONT BODY SIDE PROTECTORS

- Heavy-duty 1.25" (3.2 cm) diameter steel-tube construction.
- Front side protection for farm, ranch and forestry applications.
- Offer complete front body protection.
- Inside and outside anti-corrosion coating with durable powder coat finish.
- Require Front Bumper (715002418) with Front Corner Protectors (715002833) and Rock Slider (715002569) or Rock Sliders (715003040 for MAX models) for installation.
- Sold in pairs.

Traxter, Traxter MAX
715003450

\$XXX

FRONT RANCHER BODY SIDE PROTECTORS

- Heavy-duty 1.25" (3.2 cm) diameter steel-tube construction.
- Front side protection for farm, ranch and forestry applications.
- Offer complete front body protection.
- Inside and outside anti-corrosion coating with durable powder coat finish.
- Require Rancher Bumper (715002834) and Rock Sliders (715002569 or 715003040 for MAX models) for installation.
- Sold in pairs.

Traxter, Traxter MAX
715003617

\$XXX

RANCHER BUMPER

- Heavy-duty, rugged look.
- Front protection for farm, ranch and forestry applications.
- Low front end protection and plates for side-by-side use in cattle herds.

- Protects both vehicle and the animals.

- Headlight protection.

- Full front coverage.

- Inside and outside anti-corrosion coating with durable powder coat finish.

- Not compatible with Apache™ 360 LT Track System (715003064).

- Not compatible with Super-Duty Plow Kit (715003416), with or without Super-Duty Plow Hydraulic Angling Kit (715002840).

- Not compatible with Drop Tow Bar (715002521).

- Compatible with Alpine Flex Plow Kit (715003108).

- Not compliant with T-category vehicles.

Traxter, Traxter MAX
715002834

\$XXX



Some products shown may not be available or homologated in your country. Contact your BRP dealer for local details.



STREAMLINED PROTECTION AND FACTORY MADE FOR TRAXTER: SUBSTANCE NOW COMES WITH STYLE

NEW XT FRONT BUMPER

- 1.5" (3.8 cm) diameter steel-tube construction.
- Provides light-duty protection.
- Inside and outside anti-corrosion coating with durable powder coat finish.
- Light-kit compatible.
- Standard on XT and XT Cab models 2018 and up.
- Not compatible with Xtreme Front Bumper Plates (715003005), Front Corner Protectors (715002833) and Front LinQ Rack (715004312).

Traxter, Traxter MAX
715004407

\$XXX



NEW X MR FRONT BUMPER

- Heavy-duty 1.5" (3.8 cm) diameter steel-tube construction.
- Inside and outside anti-corrosion coating with durable finish.
- Provides additional front body protection.
- Integrated winch support plate for winch relocation at a higher position for easier access in muddy conditions or for auxiliary lights.
- Includes a front tow hook.
- Standard on X mr models.

Traxter, Traxter MAX
715004405 - Black

\$XXX

715004406 - Sunburst Yellow

\$XXX



NEW XT-P FRONT BUMPER

- Heavy-duty 1.5" (3.8 cm) diameter steel-tube construction.
- Inside and outside anti-corrosion coating with durable finish.
- Provides additional front body protection.
- Integrated mount plate for auxiliary light installation.
- Winch Support Plate (705206371) is required for winch relocation at a higher position for easier access in muddy conditions (sold separately).
- Standard on XT-P models.

Traxter, Traxter MAX
715004408 - Can-Am Red

\$XXX



INTERGRATED STEPS FOR EASIER CARGO BOX ACCESS



REAR BUMPER

- Heavy-duty 1.5" (3.8 cm) diameter steel construction and integrated tubular design.
- Increased protection of rear box and lower box corner while allowing normal tailgate function.
- Integrated steps.
- Inside and outside anti-corrosion coating with durable powder coat finish.
- Required to install Rear Body Side Protector (715003055).

Traxter, Traxter MAX

715002419

\$XXXX



REAR BODY SIDE PROTECTORS

- Heavy-duty 1.5" (3.8 cm) diameter steel-tube construction.
- Reliable cargo box protection.
- Inside and outside anti-corrosion coating with durable powder coat finish.
- Integrated brush and low-lying branch deflector.
- Require Rear Bumper (715002419) for installation.
- Compatible with fender flares.
- Sold in pairs.

Traxter, Traxter MAX

715003055

\$XXXX



SPORT FENDER FLARES

- Sleek fender flares just the right size to reduce mud and debris kick-up from your tires.
- Robust injection-molded polypropylene construction.
- Includes front and rear extension, and all mounting hardware.

Traxter, Traxter MAX

715003898

\$XXXX



FENDER FLARES

- Robust injection-molded polypropylene construction.
- Perfect for keeping mud and debris outside the vehicle.
- Includes front and rear extension, and all mounting hardware.
- Ideal for track equipped vehicles.

Traxter, Traxter MAX

715002424

\$XXXX



KEEP GROUND CLEARANCE AND ADD PROTECTION WITH COLOR-KEYED MUD-READY ALUMINUM ROCK SLIDERS



NEW X MR / XT-P ALUMINUM ROCK SLIDERS

- Heavy-duty rock sliders made of painted 3/16" (5 mm) aluminum with an integrated step for elevated cargo box access.
- Protect vehicle's sides and undercarriage against large obstacles.
- Lodge tight up against vehicle body for better clearance from obstacles.
- Not compatible with other Rock Sliders.
- Sold in pairs.
- Standard on Traxter X mr and XT-P models.

Traxter

715004409 - Black

\$XXXX

715004410 - Sunburst Yellow

715004411 - Can-Am Red

\$XXXX



ROCK SLIDERS

- Protect vehicle's sides and undercarriage against large obstacles.
- Made of heavy-duty 1.5" (3.8 cm) diameter steel tubing.
- Inside and outside anti-corrosion coating with durable powder coat finish.
- Integrated step for easy cargo box access.
- Sold in pairs.

Traxter

715002569 - Black

\$XXXX

Traxter MAX

715003040 - Black

\$XXXX



MUD FLAPS

- Keep mud and debris out of cargo area and protect trailer or vehicles behind you.
- Add aesthetic appeal to your vehicle.
- Made of EPDM rubber.
- Require Rear Bumper (715002419) for installation.
- Sold in pairs.

Traxter, Traxter MAX

715003041

\$XXXX



Some products shown may not be available or homologated in your country. Contact your BRP dealer for local details.



THERE'S TOUGH,
THERE'S RUGGED—
AND THERE'S S3-BUILT
ACCESSORIES TO DEFEND
YOUR RIDE FRONT TO BACK



S3 FRONT WINCH BUMPER

- Made of 1.5" (3.8 cm) diameter steel tubing with durable powder coat finish.
- Specifically developed for mud riding enthusiasts.
- Integrated mounting plates accommodate all winches.
- Allows higher winch position to avoid winch immersion in mud.
- Added body protection.
- Not compatible with LinQ Front Rack, Removable Winch Mounting Kit, Super-Duty Plow Push Frame Extension and Plow Pulley.
- "S3 for Can-Am" branded.
- Not compliant with T-category vehicles.

Traxter, Traxter MAX

■ 715003779 - Black

■ 715005092 - Sunburst Yellow

\$XXXX



S3 REAR WINCH BUMPER

- Made of 1.5" (3.8 cm) diameter steel tubing with durable powder coat finish.
- Specifically developed for mud riding enthusiasts.
- Integrated mounting plates for winches and towing anchor points.
- Added body protection.
- Not compatible with Apache 360 LT Track System and Removable Winch Mounting Kit.
- Compatible with Traxter winches (Rear Winch Electrical Harness required (715004233)).
- "S3 for Can-Am" branded.

Traxter, Traxter MAX

■ 715003782 - Black

■ 715005123 - Sunburst Yellow

\$XXXX



S3 NERF BARS

- Made of 1.5" (3.8 cm) diameter steel tubing with durable powder coat finish.
- Specifically developed for mud riding enthusiasts.
- Protect vehicle's lower sides without affecting ground clearance.
- Integrated step makes ingress easier.
- Not compatible with Front Body Side Protectors, Front Rancher Body Side Protectors and Apache 360 LT Track System.
- "S3 for Can-Am" branded.

Traxter

■ 715003783 - Black

■ 715005094 - Sunburst Yellow

\$XXXX

Traxter MAX

■ 715004349 - Black

■ 715005124 - Sunburst Yellow

\$XXXX





DragonFire
FOR **can-am**

IT'S A TRAIL ESSENTIAL,
TOUGH, DURABLE AND
WITH A DESIGN THAT
MAKES IT A PERFECT FIT
FOR YOUR TRAXTER



DRAGONFIRE FRONT BUMPER

- Made of 1.5" (3.8 cm) diameter steel tubing with durable powder coat finish.
- Delivers additional front protection.
- Rugged look and perfectly contoured to match vehicle's line.
- Integrated mounting plates for the 10" (25 cm) Double Stacked LED Light Bar (60 watts) and the 4" (10 cm) Round LED Lights (2 x 25 watts).

- Not compatible with Removable Winch Mounting Kit, Drop Tow Bar, Higher Front Receiver Hitch, Front and Rear Hitch Drawbar, LinQ Front Rack, Super-Duty Plow Push Frame Extension, Plow Pulley and 15" (38 cm) Double Stacked LED Light Bar (90 watts).
- "DragonFire for Can-Am" branded.

Traxter, Traxter MAX

- 715003926 - Black
- 715004168 - Squadron Green

\$XXX



DRAGONFIRE FRONT EXO-FRAME

- Made of 1.5" (3.8 cm) diameter steel tubing with durable powder coat finish.
- Full front-corner side-body and headlight protection.
- Rugged look and perfectly contoured to match vehicle's line.
- Mounting point allows the installation of a round-format light at roll cage base.
- DragonFire Bumper required for installation.
- Sold in pairs.
- "DragonFire for Can-Am" branded.

Traxter, Traxter MAX

- 715003928 - Black
- 715004170 - Squadron Green

\$XXX



DRAGONFIRE REAR EXO-FRAME

- Made of 1.25" (3.2 cm) diameter steel tubing with durable powder coat finish.
- Full cargo bed side-wall impact protection.
- Rugged look and perfectly contoured to match vehicle's line.
- Sold in pairs.
- Complements with DragonFire Rear Bumper for full rear protection.
- "DragonFire for Can-Am" branded.

Traxter, Traxter MAX

- 715003929 - Black
- 715004171 - Squadron Green

\$XXX



DRAGONFIRE SPARE TIRE HOLDER

- Made of 1.5" (3.8 cm) diameter steel tubing with durable powder coat finish.
- Easy-to-install convenient cargo bed spare-tire mount (wheel not included).
- Requires the DragonFire Cargo Bed Roll Bar.
- "DragonFire for Can-Am" branded.

Traxter (except on Mossy Oak Hunting Edition model), Traxter MAX

- 715003931 - Black
- 715004173 - Squadron Green

\$XXX



DRAGONFIRE SIDE RUNNERS

- Made of 1.25" (3.2 cm) diameter steel tubing with durable powder coat finish.
- Protect vehicle's lower side without affecting ground clearance.
- Rugged look and perfectly contoured to match vehicle's line.
- Slotted steel plate step provides extra grip and makes vehicle's access easier.
- Offer full side protection when combined with DragonFire Front and Rear Exo-Frame.
- Sold in pairs.
- "DragonFire for Can-Am" branded.

Traxter 2018 & prior

- 715003930 - Black
- 715004172 - Squadron Green

\$XXX

Traxter MAX 2018 & prior

- 715004347 - Black
- 715004348 - Squadron Green

\$XXX



DRAGONFIRE REAR BUMPER

- Made of 1.5" (3.8 cm) diameter steel tubing with durable powder coat finish.
- Rugged look and perfectly contoured to match vehicle's line.
- Integrated step provides easy cargo bed access even when the tailgate is up.
- Not compatible with Mud Flaps.
- "DragonFire for Can-Am" branded.

Traxter, Traxter MAX

- 715003927 - Black
- 715004169 - Squadron Green

\$XXX





RUGGED LOOK AND PERFECTLY CONFIGURED TO MATCH VEHICLE'S LINE

DRAGONFIRE REAR BUMPER WITH INTEGRATED STEP PROVIDES EASY CARGO BED ACCESS EVEN WHEN THE TAILGATE IS UP



DRAGONFIRE CARGO BED ROLL BAR

- Made of 1.75" (4.4 cm) diameter steel tubing with durable powder coat finish.
- Rugged look and perfectly contoured to match vehicle's line.
- Required to install the DragonFire Spare Tire Carrier.
- Not to be used as a base for mounting lights.
- Not compatible with Rear Cargo Light.
- "DragonFire for Can-Am" branded.

Traxter, Traxter MAX

715003925 - Black

715004167 - Squadron Green

\$XXX



NEW ADVENTURE ROOF RACK

- Ideal cargo solution for packing everything you need to live your off-road experience fully and completely.
- Built with heavy-duty 1.25" (3.8 cm) diameter steel tubing.
- Modular LinQ support plates allow for installation of most LinQ cargo accessories (except LinQ 4.2 gal (16L) cooler).
- Integrated mounting points for lights can hold up to 8 pod-type LED lights (6 front and 2 back) or a 39" LED bar (front).
- Features anchor points for spare tire attachment.
- Spare Tire Tie-Downs sold separately.
- Add the Cargo Box Net or the Cargo Box Elastic Net to secure and confine your cargo in the rack.
- Not compatible with Bimini Roof.

Traxter

• Loads of up to 40 lb (18 kg).

715003870

\$XXX

Traxter MAX

• Loads of up to 75 lb (34 kg).

715004391

\$XXX



DELUXE HEADACHE RACK

- Protects cab components from cargo load.
- Increases box capacity when used in tandem with the Bed Wall Extender (715002421).
- Required to install the Bed Wall Extender (715002421).
- Compatible with Gear Rail (715003391) and Gear Rail for Stronghold (715004089).

Traxter, Traxter MAX

715002423

\$XXX



HEADACHE RACK

- Full rear roll cage coverage offers a heavy-duty steel protective line of defense between your head or cab's components and the load in your cargo bed.
- Rack's open design helps maintain a clear rear view.
- Compatible with Gear Rail (715003391) and Gear Rail for Stronghold (715004089).
- Not compatible with Bed Wall Extender.

Traxter, Traxter MAX

715003873

\$XXX



Some products shown may not be available or homologated in your country. Contact your BRP dealer for local details.



CATCH THE VIDEO
CAN-AMOFFROAD.COM



BED WALL EXTENDER

- Increases box capacity.
- Quick and easy tool-less modularity.
- Easily-removable rear door can be latched open.
- Variable full or half height settings.
- Foldable top panels come off in seconds.
- Requires Deluxe Headache Rack (715002423).

Traxter, Traxter MAX
715002421

\$XXXX



TOP PANELS FOLD DOWN INSTANTLY.



LinQ TAILGATE EXTENSION/DIVIDER

- Adds rear cargo capacity when the tailgate is open.
- Steel-tubing-system-style barrier mounts on top of the bed walls using the easy, tool-less LinQ System.
- Can be mounted to serve as cargo divider at different locations along the bed wall while preventing larger items from falling off the back.
- Stores neatly out of the way and offers additional cab area protection since it can be mounted upside down on the front bed wall as a mini headache rack.
- Inside and outside anti-corrosion coating with durable powder coat finish.

Traxter, Traxter MAX

715002464

\$XXXX



CARGO DIVIDER



HEADACHE RACK



TONNEAU COVER

- Fitted to cover all of the items in your cargo box thoroughly.
- Prevents splash from entering the cargo box.
- Rolls up to the front.
- Easily removable for quick access.
- Not compatible with accessories that exceed the box height.

Traxter (except Mossy Oak Hunting Edition model), Traxter MAX

715003017 - Black

\$XXXX

715003048 - Mossy Oak Break-Up Country Camo

\$XXXX



LinQ TIRE HOLDER

- Cargo box spare-tire holder.
- Heavy-duty steel construction.
- Inside and outside anti-corrosion coating with durable powder coat finish.
- Mounts on top of the bed walls using the easy, tool-less LinQ System.
- Compatible with Bed Wall Extender.
- Uses BRP standard wheel bolt pattern to mount tire (nuts included).
- Accommodates BRP tires up to 28" (wheel not included).
- Quickly allows installation in multiple positions thanks to the LinQ System.

Traxter (except Mossy Oak Hunting Edition model), Traxter MAX

715003448

\$XXXX



QUICK & EASY TOOL-LESS LinQ MULTIPOINT INSTALLATION



LinQ ADAPTOR

- Allows the installation of the LinQ Tool Holder (715003059) to the Bed Wall Extender (715002421) or the Deluxe Headache Rack (715002423).
- Sold in pack of 4.

Traxter, Traxter MAX

715003058

\$XXXX

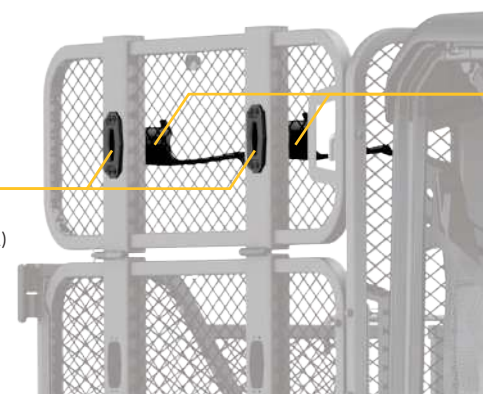

LinQ TOOL HOLDER

- Ultra-versatile tool holder.
- Convenient swivel-latch allows tools to be stored in any orientation.
- Suitable for installation onto the cargo walls, Deluxe Headache Rack (715002423), or Bed Wall Extender (715002421).
- If mounted on the Deluxe Headache Rack (715002423) or the Bed Wall Extender (715002421), LinQ Adaptor (715003058) is required for installation.
- Sold in pairs.

Traxter, Traxter MAX

715003059

\$XXXX



Some products shown may not be available or homologated in your country. Contact your BRP dealer for local details.

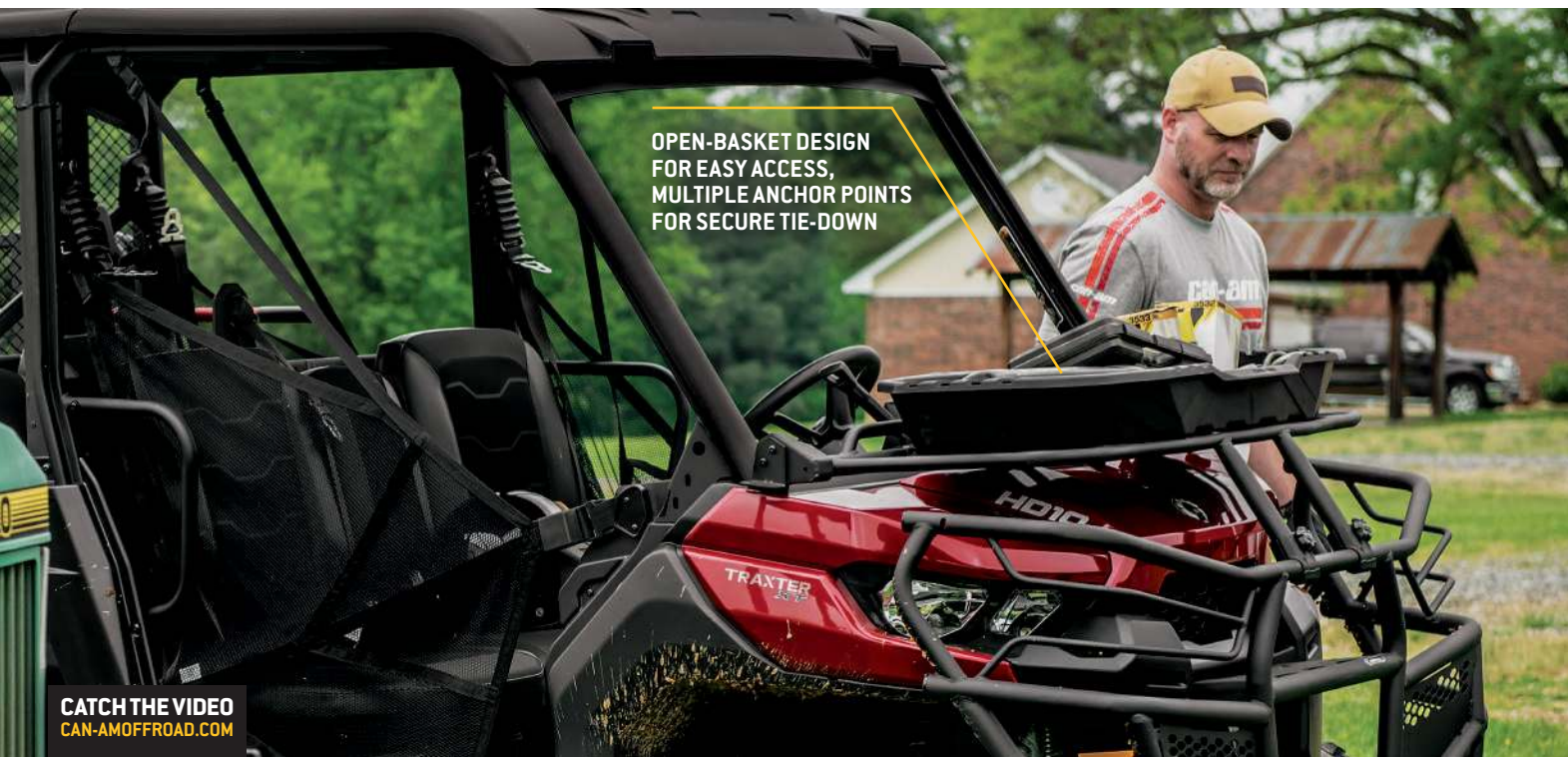

CATCH THE VIDEO
CAN-AMOFFROAD.COM



LinQ LOW PROFILE BASKET

- Low profile, open basket increases cargo space.
- Perfect for easy access to tools, rope, winch and plow accessories.
- Multiple bungee cord and tie-down anchor points.
- Made of impact-resistant injected polypropylene.
- LinQ Cargo Rack (715004281) or LinQ Front Rack (715004312) is required for installation.

Traxter, Traxter MAX
715003027

\$XXXX



LinQ HEAVY-DUTY BASKET

- Made of high-strength, low-alloy steel.
- LinQ mount for easy-on, easy-off installation.
- Can be placed on the LinQ Front Rack (715004312) and the LinQ Cargo Rack (715004281).

Traxter, Traxter MAX
715001215

\$XXXX



LinQ FRONT RACK

- Rugged looking front rack mounts on top of vehicle hood and provides additional storage.
- Heavy-duty 1.25" (3 cm) diameter steel-tube construction.
- Inside and outside anti-corrosion coating with durable powder coat finish.
- Flip-up configuration provides easy access to service area.
- Allows the installation of LinQ accessories (especially for use with LinQ Low Profile Basket (715003027)).
- Kit includes LinQ Base.
- Multiple bungee cord and tie-down anchor points.
- Requires Rancher Bumper (715002834) or Front Bumper (715002418) for installation.
- A great place to store tools while working in the field.

Traxter, Traxter MAX
715004312

\$XXXX



LinQ CARGO RACK

- Strong, durable steel rack.
- Easy and tool-less installation thanks to the LinQ System.
- Allows the installation of LinQ accessories.
- 2 racks can be installed at the same time.
- Allows multi-level storage on cargo bed (accommodates 5 Gal (19L) bucket).
- Helps keep cargo securely in place.
- Multiple bungee cord and tie-down anchor points.
- Kit includes LinQ Base.
- Provides more usable space in the cargo box.
- Extends vehicle cargo options.

Traxter, Traxter MAX
715004281

\$XXXX



REMOVABLE STORAGE BIN

- Handy, removable on-dash toolbox will make sure you have your critical equipment where you need it.
- Provides 1.7 Gal (6.3 L) of storage, and clips on and off in a snap.
- Water-resistant to ensure your contents remain safe and dry.
- Standard on all models except Base.

Traxter, Traxter MAX
715004344

\$XXXX



DRIVER UNDERSEAT STORAGE BIN

- Polypropylene-injected 4 Gal (15L) capacity bin fits securely under the driver's seat.
- Front opening for quick and easy access.
- Ideal for storing weather-resistant items, such as ropes, tow straps and winch accessories that are needed at a moment's notice.

Traxter, Traxter MAX
715003399

\$XXXX



REMOVABLE STORAGE BIN - PASSENGER

- Convenient passenger-side underseat storage polypropylene-injected 3.7 Gal (14L) storage capacity bin.
- Bin installs and removes in a snap and comes with an integrated handle.
- Water-resistant.

Traxter, Traxter MAX
715003314

\$XXXX



CENTER UNDERSEAT STORAGE BIN

- Polypropylene-injected 2 Gal (8L) capacity storage bin.
- Watertight design keep ice and drinks cold.
- Easy to drain and wash by removing it with integrated handle.
- Accessible by lifting center seat section.

Traxter, Traxter MAX
715003446

\$XXXX



Some products shown may not be available or homologated in your country. Contact your BRP dealer for local details.

CARGO BED RAILS

- Add integrated tie-down area to your cargo box while enhancing the look.
- Added cargo box protection.
- Inside and outside anti-corrosion coating with durable powder coat finish.
- Heavy-duty 1" (2.5 cm) diameter steel-tube construction.
- Add height to the bed sidewall and serve as a tie-down anchor for ropes, straps or bungees.
- Not compatible with Bed Wall Extender (715002421).
- Sold in pairs.

Traxter, Traxter MAX

715003444

\$XXXX



DASH STORAGE COMPARTMENT NETS

- Perfect for securing items in the dash storage area.
- Not compatible with Defrost, Heat & Ventilation System (715004916).
- Sold in pairs.

Traxter, Traxter MAX (except XT Cab models)

715003129

\$XXXX



DASH STORAGE COMPARTMENT NET FOR HEATING SYSTEM

- Perfect for securing items in the dash storage area.
- To be installed when Defrost, Heat & Ventilation System (715004916) is in place.

Traxter, Traxter MAX

715003544

\$XXXX



CARGO BED NET

- Solid net designed to hook to the bottom of the cargo box for secure and compact confinement of your cargo.
- Keeps items tightly against the bed floor.

Traxter, Traxter MAX

715003445

\$XXXX



BACKREST REAR STORAGE

- Netting installs easily.
- Made from polyester that won't discolor.
- Sold in pairs.

Traxter MAX

715003019

\$XXXX



LOWER DASHBOARD FOR HEATING SYSTEM

- Replaces the dashboard that comes stock with the vehicle, and features a tablet that makes it possible for driver and passenger to conveniently store small items in the dash.
- To be used when the Defrost, Heat & Ventilation System (715004916) is installed.
- Use together with the Dash Storage Compartment Net for Heating System (715003544) to prevent the items placed in the dash storage compartment from falling.

Traxter, Traxter MAX

715003441

\$XXXX



BED TOOL BOX

- Large 40 Gal (150L) multifunction weather-resistant tool box designed for cargo beds.
- Rotomolded construction provides exceptional rigidity and durability.
- Features cup holders and integrated groove for pipe or 2x4 cutting.
- Sized to give you the option of installing 2 tool boxes in the cargo bed (quick bolt-on installation).
- Double side openings with lockable covers and rubber latches.

Traxter, Traxter MAX

715003028

\$XXXX

MULTIFUNCTION CARGO BED TOOL BOX: BUILT TO BEAT HARD KNOCKS & ROUGH WEATHER

MUST HAVE



CARGO BAG

- Rugged all-purpose cargo bag with rain cover for additional protection against the elements.

Traxter, Traxter MAX

280000539

\$XXXX



RAIN COVER FOR ADDITIONAL PROTECTION



STORAGE 2.6 GAL (10L) BAG

- Roll-top dry bag for fully protecting your cargo from the elements.

Traxter, Traxter MAX

269502121

\$XXXX



ROOM TO GO.
EQUIPPING YOUR TRAXTER WITH AMPLE CARGO CAPACITY ONLY MAKES PACKING EASIER, AND THE RIDE, BETTER



NEW LinQ 4.2 GAL (16 L) COOLER

- All the benefits of LinQ - simple, fast and secure.
- LinQ-mounted weather-resistant 4.2 Gal (16 L) cooler.
- Rotomolded construction for exceptional rigidity and durability.
- Premium-quality foam insulation for optimal ice retention.
- Utilizes LinQ mounting system (Patent US 8777531 and US 8875830).
- Easy one-second on/off tool-less system.
- LinQ Cargo Base Kit (860201806) required for installation.
- LinQ Cargo Rack (715004281) or Adventure Roof Rack is required for installation.

Traxter, Traxter MAX
295100698

\$XXXX



NEW SR 5.5 GAL (21L) LinQ BAG

- All the benefits of LinQ - simple, fast and secure.
- Semi-rigid expandable bag.
- 5.5 Gal (21L) capacity.
- Utilizes LinQ mounting system (Patent US 8777531 and US 8875830).
- Easy one-second on/off tool-less system.
- LinQ Cargo Base Kit included (860201806).
- LinQ Cargo Rack (715004281) or Adventure Roof Rack is required for installation.

Traxter, Traxter MAX
860201740

\$XXXX



LinQ CARGO BASE KIT

- Unique mounting fastener usable on any LinQ System accessory.
- Included: 2 Cargo LinQ bases and hardware.

Traxter, Traxter MAX
860201806

\$XXXX



LinQ REPLACEMENT PART

- (Not illustrated)
- Unique mounting fastener usable on any LinQ System accessory.
- Tool-less installation and removal.
- Sold in pairs.

Traxter, Traxter MAX
715001707

\$XXXX

Some products shown may not be available or homologated in your country. Contact your BRP dealer for local details.



CATCH THE VIDEO
CAN-AMOFFROAD.COM



LinQ 12 GAL (45L) CARGO BOX

- Holds cargo safely and securely while riding.
- LinQ mounted for easy-on, easy-off installation.
- LinQ Cargo Rack (715004281) is required.

Traxter, Traxter MAX
715003879

\$XXXX



LinQ 11.5 GAL (43L) AUDIO CARGO BOX

- An affordable and quick solution for adding music and storage to your next ride. The rear installation does not use up any cab space and allows easy listening at an average speed.
- Mounts on/off easily to hold/carry cargo safely and securely.
- The Bluetooth enabled receiver and 6.5" (16.5 cm) speakers are smartly concealed and integrated in the cover.
- Automatic shut-off function protects your battery by turning the system off after 10 minutes of inactivity.
- Backlit control panel perfect for night riding.
- Water-resistant speakers.
- LinQ Cargo Rack (715004281) is required.

Traxter, Traxter MAX
715003018

\$XXXX

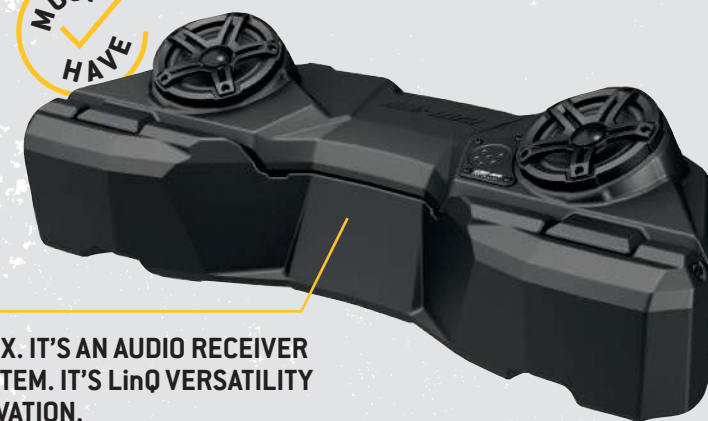

IT'S A CARGO BOX. IT'S AN AUDIO RECEIVER & SPEAKER SYSTEM. IT'S LinQ VERSATILITY & CAN-AM INNOVATION.

SOFT STORAGE BAG

- 3-section bag.
- Transport gear in a weatherproof bag.
- 11.8 Gal (45L) capacity soft cargo bag designed with vehicle's rear in mind to maximize potential storage.

Traxter, Traxter MAX
715003759 - Black

\$XXXX

715001935 - Mossy Oak Break-Up Country Camo

\$XXXX



Vehicle shown is a Can-Am Outlander.



Vehicle shown is a Can-Am Outlander.



**TOUGH & DURABLE
KOLPIN GUN BOOTS
KEEP YOUR FIREARMS
SAFE, DRY, AND AT HAND**



STRONGHOLD GUN BOOT IMPACT[®] BY KOLPIN[†]

- Compact low-profile design with Kolpin Stronghold styling securely holds up to 52" long rifles and shotguns with optics.
- Includes a removable, shock absorbing foam Impact[®] liner.
- Single-handed opening with an attached lid for quick access along with an integrated closure strap.
- For use with the Kolpin Stronghold Auto-Latch Mount System.

Traxter, Traxter MAX
705011442

\$XXX



**THE WORLD'S MOST POPULAR
HARD GUN CASE SINCE 1973**

GEAR RAIL FOR STRONGHOLD

- Designed for the Stronghold Auto-Latch Mount by Kolpin.
- Can hold up to two Stronghold Gun Boots (two Latch mounts required).
- Deluxe Headache Rack (715002423) or Gear Rail Adaptor (715003392) required.
- Standard on Traxter Mossy Oak Hunting Edition.

Traxter, Traxter MAX
715004089

\$XXX

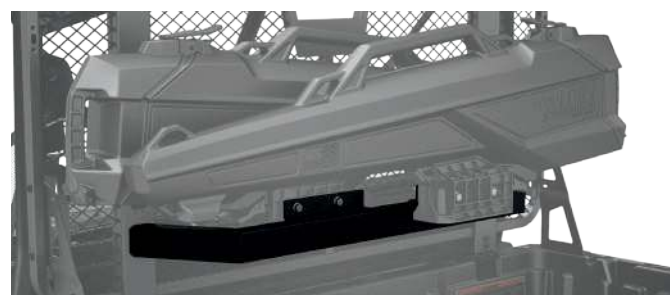

STRONGHOLD AUTO-LATCH MOUNT BY KOLPIN

- Auto-latching design provides quick and secure gun boot attachment to your vehicle.
- Bracket is made from rugged high-impact, reinforced nylon and coated steel.
- For use with Stronghold Gun Boot (705011442).
- Requires Gear Rail For Stronghold (715004089).
- Standard on Traxter Mossy Oak Hunting Edition.

Traxter (except X mr models), Traxter MAX
715003899

\$XXX



DOUBLE GUN BAG

- Shell constructed with heavy-duty, weather-resistant polyester to shelter guns from dust and other outdoor elements, while the thick interior padding protects the guns from shocks.
- Fits perfectly on rear cage, and guns are readily accessible from both sides of vehicle.
- Design features include a removable center pocket that can be mounted on both sides of the bag, and extra front storage pockets for hunting gear.
- Solid, quick installation.
- Not compatible with rear wind protections, headache racks and gear rails.

Traxter (except XT Cab, X mr & Mossy Oak Hunting Edition models), Traxter MAX (except XT Cab)

715003133 - Black

\$XXX



715003134 - Mossy Oak Break-up Country

\$XXX



GEAR RAIL

- Stationary rail system specially designed for your side-by-side vehicle.
- Universal mounting options for many Kolpin accessories like Gear Grips, Gun Boot 6.0, Gun Boot Mount and Universal Saw Press.
- Rail is made with heavy-duty 7-gauge extruded anodized black aluminum.
- Mounts on roll bar.
- Includes one versatile Gear Rail Mount by Kolpin (715001422).
- Requires Deluxe Headache Rack (715002423), Headache Rack (715003873) or Gear Rail Adaptor (715003392).

Traxter (except X mr models), Traxter MAX

715003391

\$XXX



GEAR RAIL ADAPTOR

- Allows the installation of gear rails directly onto the cargo box without the need for a headache rack.

Traxter (except X mr & Mossy Oak Edition models), Traxter MAX

715003392

\$XXX



GEAR RAIL MOUNT BY KOLPIN

- Accessory bracket for mounting additional accessories to the Gear Rail.
- Includes C-clamp and metal mounting brackets.

Traxter, Traxter MAX

715001422

\$XXX

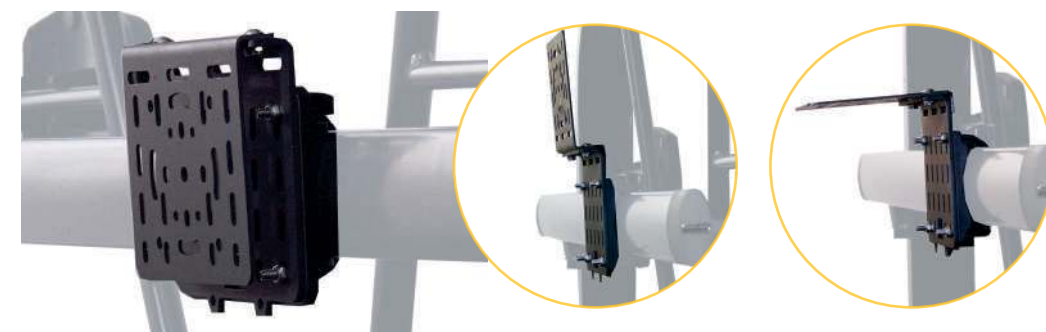

Some products shown may not be available or homologated in your country. Contact your BRP dealer for local details.



GUN BOOT 6.0 IMPACT BY KOLPIN

- Extra room for pistol-grip-type weapons and small bipods.
- Easily fits firearms up to 51" (1.3 m) in total length.
- Provides ample room for 2.4" (60 mm) scopes.
- Hatchback design allows easy access.
- Snap-close cover with locking capability.
- Ergonomically designed handle and molded attachment points for sling.

- Designed to accommodate left and right hand bolt-action rifles and shotguns.
- Requires Gear Rail and Gun Boot Mount by Kolpin for installation.
- Includes removable, shock absorbing foam and nylon Impact liner for superior interior protection.
- Compatible for dual mount with Additional Gun Boot Mount.

Traxter, Traxter MAX

715001419

\$XXXX



LOCKABLE SNAP-CLOSE COVER



UNIVERSAL SAW PRESS BY KOLPIN

- Specially crafted for transporting your chainsaw securely and safely aboard your side-by-side vehicle.
- Heavy-duty, black powder-coated metal bracket designed to attach any chainsaw model with up to a 20" (51 cm) bar.
- Rubber pads provide cushion and tight fit.
- Hinged design for quick removal.
- Holds saw in vertical position or 45° angle in either direction.
- Requires Gear Rail.
- Protective sheath included.

Traxter, Traxter MAX

715001423

\$XXXX



Vehicle shown is a Can-Am Commander.



GEAR GRIPS BY KOLPIN

- Durable, flexible grips cushion and protect while providing a custom fit for a variety of items from 1" to 4" (2.5 cm to 10 cm) in diameter.
- Heavy-duty design for carrying bows, fishing poles, rakes, farm tools and more.
- Quick-release button opens grip quickly for easy access to gear.
- Heavy-duty base system built for the toughest adventures.
- Easy installation on tubular racks, extension racks, brackets or bumpers.
- Sold in pairs.

Traxter (standard on Mossy Oak Hunting Edition model), Traxter MAX

715001421

\$XXXX



QUICK-RELEASE BUTTON FOR EASY ACCESS TO GEAR

Some products shown may not be available or homologated in your country. Contact your BRP dealer for local details.



GUN BOOT MOUNT BY KOLPIN

- Fits one Kolpin Gun Boot 6.0 Impact (715001419).
- Lightweight and extremely durable.
- Easily adjustable without the use of any tools.
- Offers precision gun angle adjustability.
- Requires Gear Rail for installation.

Traxter, Traxter MAX

715001420

\$XXXX



ADDITIONAL GUN BOOT MOUNT

(Not illustrated)

Traxter, Traxter MAX

715001586

\$XXXX

LED LIGHTS

8,400 LUMENS



Lights up to more than 1900 ft (580 m) in front of the vehicle and around 65 ft (20 m) wide on each side.

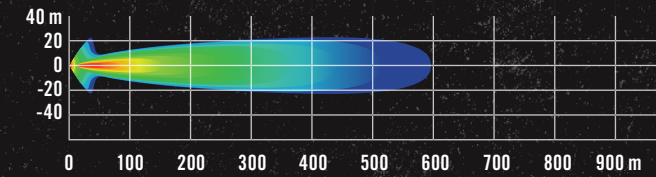

5,400 LUMENS



Lights up to more than 1500 ft (460 m) in front of the vehicle and around 65 ft (20 m) wide on each side.

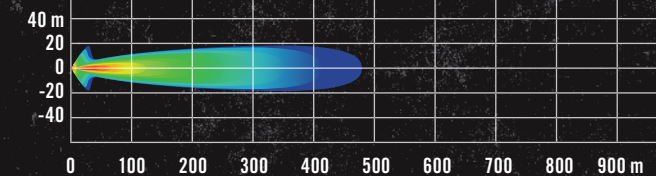

2 X 1,800 LUMENS



Perfect fit with the Light Rack for Sport Visor and most bumpers with Light Mount Kit.

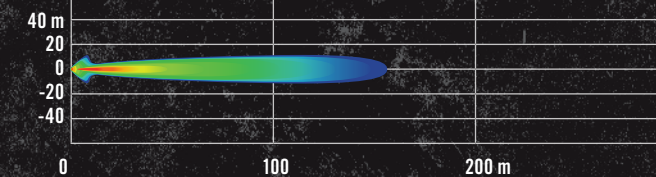

15" (38 CM) DOUBLE STACKED LED LIGHT BAR (90 WATTS)

- Equipped with 18 5W Cree LEDs.
- 8,400 lumens.
- Complements the Light Rack and most bumpers.
- Can be installed on Sport Roof and Bimini Roof.
- Includes wiring kit and switch.
- Not EC compliant.

Traxter, Traxter MAX

715002934

\$XXXX

10" (25 CM) DOUBLE STACKED LED LIGHT BAR (60 WATTS)

- Equipped with 12 5W Cree LEDs.
- 5,400 lumens.
- Packs a big punch for its size.
- Can be installed on Can-Am Front Bumpers, Sport Roof and Bimini Roof.
- Includes wiring kit and switch.
- Not EC compliant.

Traxter, Traxter MAX

715002933

\$XXXX

4" (10 CM) ROUND LED LIGHTS (2 X 25 WATTS)

- 25W LED spotlights.
- 2 x 1,800 lumens.
- Rugged and waterproof.
- Includes basic wiring and switch.
- Can-Am branded grill.
- Sold in pairs.
- Not EC compliant.

Traxter, Traxter MAX

715002935

\$XXXX

BUILD YOUR LIGHTING SYSTEM

Refer to pages 42 & 43

*All lights are intended for Off-Road use only.

EXTEND THE GOOD TIMES WITH LIGHTS CUSTOM FIT FOR YOU

10" (25 CM) DOUBLE STACKED LED LIGHT BAR (60 WATTS)



LIGHT RACK

- Rugged steel construction serves as both mount and protection for accessory light systems.
- Lights not included.
- Front Roof Liner is required for installation on the roof (except Cab models or with Deluxe Sport Roof (715002511)).
- Power Cable (715003094), Sport Roof (715002430), Bimini Roof with Sun Visor (715002849), Deluxe Sport Roof (715002511) or Sport Roof for MAX (715003038) required for installation (except Cab models).
- Integrates elegantly and seamlessly into our roof products.

Traxter, Traxter MAX

715002456

\$XXXX



REAR CARGO LIGHT

- Powerful 55W H3 illumination for rear cargo area.
- Convenient in-dash switch.
- Wiring included.
- Sport Roof (715002430), Deluxe Sport Roof (715002511) or Sport Roof for MAX (715003038) is required for installation.
- Not EC compliant.

Traxter, Traxter MAX

715002422

\$XXXX



RAM LED SPOTLIGHT

- 540 lumens LED light (9 Watt) heavy-duty spotlight standard-equipped with 1" (2.5 cm) diameter rubber-coated double ball and socket system.
- Not EC compliant.

Traxter, Traxter MAX

710005423

\$XXXX



DOME LIGHT

- LED array integrates perfectly with vehicle.
- Wiring included.
- Can be installed on cage or roof, with or without roof liner.

Traxter, Traxter MAX

715002455

\$XXXX



POWER CABLE

- (Not illustrated)
- Brings power from the battery.
- Required for installation of some electrical accessories.

Traxter, Traxter MAX

715003094

\$XXXX

LIGHT KIT POWER CABLE

- (Not illustrated)
- Power cable for installation of compatible Can-Am light kits at front bumper location.

Traxter, Traxter MAX

715002454

\$XXXX

BUILD YOUR LIGHTING SYSTEM IN 4 EASY STEPS

1. FIND YOUR PLATFORM	2. CHOOSE YOUR MOUNT POINT	3. CHOOSE YOUR LIGHTS			4. ORDER
		10" (25 CM) LED BAR P.41	15" (38 CM) LED BAR P.41	4" (10 CM) ROUND LED LIGHTS (SOLD IN PAIRS) P.41	
TRAXTER, TRAXTER MAX	FRONT BUMPER RANCHER BUMPER XT FRONT BUMPER X MR FRONT BUMPER (W/O WINCH) X-TP FRONT BUMPER	715002933 PLUS: 715002454 (Light Mount Kit)	715002934 PLUS: 715002454 (Light Kit Power Cable)	715002935 PLUS: 715002454 (Light Kit Power Cable)	ORDER ALL PART NUMBERS IN THE INTERSECTING BOX *NOTE: When installing more than one LED light kit on a light rack, you only need to order one rack and one power cable.
	LONE STAR EDITION FRONT BUMPER	715002933 PLUS: 715002454 (Light Mount Kit)	N/A	N/A	
TRAXTER, TRAXTER MAX (EXCEPT XT CAB)	SPORT ROOF, DELUXE SPORT ROOF OR BIMINI ROOF *Front Roof Liner (715003098) is required (except for Deluxe Sport Roof (715002511))	715002933 PLUS: 715002456 (Light Rack) & 715003094 (Roof Power Cable)	715002934 PLUS: 715002456 (Light Rack) & 715003094 (Roof Power Cable)	715002935 PLUS: 715002456 (Light Rack) & 715003094 (Roof Power Cable)	
	ROOF WITH A DELUXE XT RIGID CAB ENCLOSURE *Front Roof Liner (715003098) is required (except for Deluxe Sport Roof (715002511))	715002933 PLUS: 715002456 (Light Rack)	715002934 PLUS: 715002456 (Light Rack)	715002935 PLUS: 715002456 (Light Rack)	
	ROOF OF THE PREMIUM RIGID CAB ENCLOSURE	715002933 PLUS: 715002456 (Light Rack)	715002934 PLUS: 715002456 (Light Rack)	715002935 PLUS: 715002456 (Light Rack)	
TRAXTER XT CAB	DELUXE SPORT ROOF	715002933 PLUS: 715002456 (Light Rack)	715002934 PLUS: 715002456 (Light Rack)	715002935 PLUS: 715002456 (Light Rack)	

Some products shown may not be available or homologated in your country. Contact your BRP dealer for local details.



RUGGED RADIOS CAR-TO-CAR SYSTEM

- Perfect for communicating with friends and family on group rides.
- Push-to-talk button conveniently mounted on the steering wheel.
- Includes radio mounting bracket, helmet speaker, mic kit and base charger.
- 2-4 mile range.

- This kit includes:
RH-5R Rugged Radios 5-Watt Dual Band Handheld Radio
Helmet Speaker / Mic Kit
Push-to-talk buttons
Mounting bracket
Base station charger

Traxxer, Traxxer MAX
715003440

\$XXXX



OVERHEAD AUDIO SYSTEM

- Rugged waterproof Jensen® Bluetooth Stereo Audio system offers multi-source input: AM/FM/WB and USB (iPod® and iPhone® ready).
- Convenient white LED-backlit LCD display and buttons.
- Stream from any Bluetooth-enabled device (smartphone, MP3 player).
- Powerful 4x40W amplifier with remote turn-on.
- Voice-control of AVRCP-active device.
- 30 programmable AM/FM stations with auto-store/pre-set scan.
- Separate RCA audio output and input.
- UV-resistant finish / corrosion-resistant components.
- Requires Sport Roof (715002430 (except on XT and Mossy Oak Hunting Edition models)), Front Roof Liner (715003098) or Deluxe Sport Roof (715002511) and Power Cable (715003094) (except if you already have a Hard Cab Enclosure (715001966 or 715003482)).



COMPLETE OVERHEAD AUDIO SYSTEM

- Complete with 4 ultra-sturdy outdoor speakers (2 front and 2 rear) and 4 black speaker boxes.

Traxxer, Traxxer MAX
715002019

\$XXXX

OVERHEAD FRONT AUDIO SYSTEM

- Complete with 2 ultra-sturdy front outdoor speakers and black speaker box.

Traxxer, Traxxer MAX
715003095

\$XXXX

RUGGED WATERPROOF JENSEN BLUETOOTH STEREO AUDIO SYSTEM WITH MULTI-SOURCE INPUTS, POWERFUL REMOTE ON/OFF AMPLIFIER, AND UP TO 4 ULTRA-STURDY OUTDOOR SPEAKERS



THE EASIEST WAY TO TILT YOUR TRAXTER'S BED

DIGITALLY ENCODED SECURITY SYSTEM (D.E.S.S.™) KEYS

- Top-security anti-theft protection for your vehicle.
- Encrypted chip technology restricts access to your vehicle's electronic ignition system.
- One vehicle / One code.
- A vibration / shock-resistant ball-and-socket design that ensures a reliable connection.
- Comes with 3 programmable keys:
- Work key: limits vehicle speed to 40 kph (25 mph) but does not limit engine torque.
- Normal key: limits vehicle speed to 70 kph (44 mph) and 10% torque reduction.
- Performance key: No restrictions.

Traxxer, Traxxer MAX

715002458

\$XXXX

IDEAL FOR WORK ENVIRONMENT



3-MODE SWITCH

- Switches quickly and conveniently between normal/ work/eco modes.
- Work mode: Reduced throttle sensitivity for smoother acceleration and reduced load impact.
- Eco mode: Increased fuel economy.
- In-dash plug-and-play mount.
- Standard on XT, XT Cab and Mossy Oak Hunting Edition models.

Traxxer, Traxxer MAX

715004445

\$XXXX



POWER TILT-BED

- Powerful cargo box tilter with dash integrated switch.

Traxxer, Traxxer MAX
715000829

\$XXXX



REAR 12V POWER OUTLET

- Kit brings power source to the cargo box area.
- Installs into the rear cab firewall.
- Easy plug-in harness included.
- Standard on the Traxxer Mossy Oak Hunting Edition.

Traxxer, Traxxer MAX

715003846

\$XXXX



NEW USB POWER OUTLET KIT

- Recharges your electronic devices while riding* (smartphone, MP3, heating gear, etc.).
- Dual port USB connectors.
- Plug-and-play kit.
- Simply connect under driver seat and use.
- *The power outlet is not capable of recharging all device types while riding.

Traxxer, Traxxer MAX

219400510

\$XXXX



Some products shown may not be available or homologated in your country. Contact your BRP dealer for local details.

BACK-UP MONITOR AND CAMERA KIT

- Fully waterproof rear view camera and monitor kit.
- The camera is one of the clearest and sharpest available on the market, with 250,000 pixel image resolution and a 2.1 mm lens with 130° viewing angle.
- Features 18 infrared lights that allow up to 50 ft. visibility in complete darkness, an auto iris sensor that adapts to light intensity changes and an adjustable sunshade.
- 7" digital TFT LCD color monitor comes with power harness and can support up to two camera inputs.
- The camera can be roof mounted to monitor your cargo load or to see farther behind, and it can be mounted under the cargo box for hitching purpose.

Traxter, Traxter MAX

715003834

\$XXX



AUXILIARY BATTERY INSTALLATION KIT

- Allows you to add a second 30Ah battery for that dual battery setup that will give you the extra juice you'll need to power auxiliary electrical components like a sound system or winch.
- Equipped with an integrated smart battery isolator that will prevent your auxiliary electrical components from draining your starting battery.
- Kit includes an additional battery junction block, all necessary wiring and the battery holder.
- Additional battery sold separately (515176151).

715003758

\$XXX



RAM GPS MOUNT

- Allows for GPS integration onto vehicle.
- Standard AMPS hole pattern for Garmin Cradle.

Traxter, Traxter MAX

715003325

\$XXX



GARMIN MONTANA 680T GPS

- Rugged and waterproof, the Montana 680T is element-proof.
- 4-inch dual-orientation, sunlight-readable touchscreen and glove-friendly touchscreen display, to give you vivid colors and high-resolution images.
- 8-megapixel autofocus camera automatically geotags photos.
- Tracks both GPS and GLONASS satellites for improved positioning and typically faster fixes.
- Preloaded TOPO maps, plus 1-year BirdsEye Satellite Imagery subscription.
- 3-axis compass with barometric altimeter.
- Specific GPS cradle included (vehicle mounting kit required).
- Includes a preloaded map for US.
- RAM GPS Mount (715003325) required on Traxter.

Traxter, Traxter MAX

715002830

\$XXX

European Version

- EC compliant.
- Includes preloaded European recreation map.

715003456



NEW BATTERY CHARGER/MAINTAINER

- Fully automatic 3 amp battery charger / maintainer.
- Keeps stored lead-acid batteries charged.
- Charges and maintains small batteries.
- Microprocessor controlled multi-stage charging for added precision, safety and battery life.
- Float mode monitoring automatically maintains optimum battery charge.
- Reverse hook-up protection helps protect battery and charger from damage.
- Automatically detects 6 or 12 volt batteries.
- Hook attachment hangs outside the work area for safety and convenience.
- Press the display button to show the charge progress.
- Energy efficient/eco friendly, meets the highest industry standards for energy efficiency
- Content: 3 amp battery charger, clamp adapter, DC adapter, 24" fused ring leads harness with weather cap, owner's manual.
- US plug (110V).

715005061

\$XXX



NEW JUMP STARTER

- IPX3 water-resistant and enclosed output ports.
- 4 LED battery indicators for easy read on battery charge level.
- Compact design, will conveniently fit in your backpack, glove box or any other storage compartment.
- Quickly starts vehicles in emergencies.
- Great for powersport vehicles, motorcycles and 4 and 6 cylinder vehicles.
- 2.4A + 1A/5V USB ports for fast charging of all USB devices, including smartphones, MP3 players and tablets.
- Smart cable provides protection against reverse polarity, short circuit, low voltage, high temperature and reverse charging.
- Built-in LED light (3 modes).
- Content: 300CA jump starter, SA858 smart cable clamp, MC-USB to USB charging cable, travel bag, user manual.

715005062

\$XXX



CTEK BRP 5.0 BATTERY CHARGER

- CTEK, the manufacturer of the smartest battery chargers in the world, has produced a BRP specific charger for all BRP products.
- Charger is built to meet the demanding arctic conditions.
- Ask your dealer for more information.

860200997

\$XXX



NEW QUICK CONNECT BATTERY CABLE

- (Not illustrated)
- Quickly and easily connect and charge different items with your charger.
- Included in the Battery Charger/Maintainer (715005061).
- Sold individually.

715005408

\$XXX

ARE YOU READY FOR WINTER?

HEATED, RUGGED, WINTER-READY ACCESSORIES MADE FOR CAN-AM TRAXTER



HEATED GRAB BAR COVER

- Made tough to hold up to the stresses of rough riding, this heated cover will keep your passenger's hands warm and securely gripped during long cold outings.
- Easy to install and remove.
- This kit includes the heated grab bar cover and in-dash switch.
- Heated Accessory Electrical Harness (710005757) is required.

Traxter, Traxter MAX

715003835

\$XXX



HEATED SEAT COVER

- Made of rugged vinyl, this heated seat cover delivers chill-free riding comfort.
- Ergonomically designed to fit snugly over the seat, it is also easy to install and remove.
- Hi/Low temperature settings allow you to control the desired degree of warmth.
- This kit includes the heated seat cover and in-dash switch.
- Heated Accessory Electrical Harness (710005757) is required.

Traxter, Traxter MAX

715003836 • Driver

\$XXX

715004296 • Passenger

\$XXX





DEFROST, HEAT & VENTILATION SYSTEM

- Best integrated system on the market with 3-ventilation speed and in-dash adjustable temperature.
- Adjustable/directional vents.
- 10 vents specially positioned for better windshield and side windows defrosting/deicing, foot and hand heat.
- Easy-service air filter.
- Once installed, you might want to add storage space with the Lower Dashboard for Heating System (715003441) and Dash Storage Compartment Net for Heating System (715003544).

Traxter, Traxter MAX (not compatible with HD5 Motorization)

715004916

\$XXXX

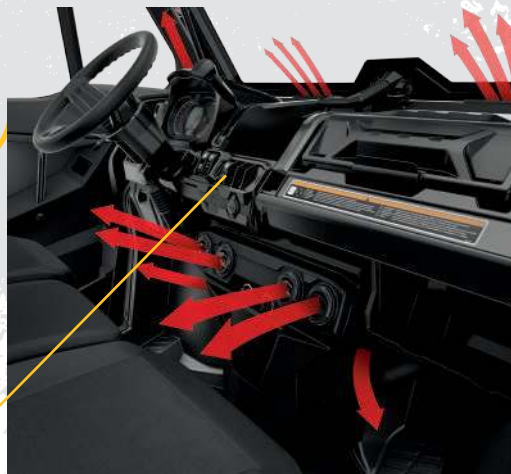

MARKET-LEADING FULLY-INTEGRATED IN-DASH ADJUSTABLE HEATING SETTINGS & WINDSHIELD CONDENSATION CONTROL

NEW RADIATOR WINTER FRONT

- Allows you to get higher heating temperature out of the Defrost, Heat & Ventilation System in extremely cold conditions.

Traxter, Traxter MAX

715005108

\$XXXX



HEATED STEERING WHEEL

- Ruggedly-constructed steering wheel designed to withstand cold conditions while channeling heat directly to your hands.
- Perfect for making hand mobility and grip readily available, e.g. hunting, manual farming.
- Replaces stock steering wheel.
- This kit includes the heated steering and in-dash switch.
- Heated Accessories Wiring Harness (710005757) is required.
- Not EC compliant.

Traxter, Traxter MAX

715003837

\$XXXX



GET YOUR HANDS ON OUTSTANDING FINGERTIP WARMTH

HEATED ACCESSORIES WIRING HARNESS

(Not illustrated)

- Electric harness required to hook up and operate heated accessories.
- Power up to 4 accessories: 2 hand accessories (grab bar/steering wheel) and 2 seat covers.

Traxter, Traxter MAX

710005757

\$XXXX

HEATED VISOR OUTLET

- Strategically positioned on vehicle to maintain your agility.
- Optional visor outlet that delivers fog-free riding.
- Quick and easy installation.
- Sold individually.
- Heated Visor not included.

Traxter, Traxter MAX

715001246

\$XXXX



WARN⁺ PROVANTAGE

- Patented roller disc brake for enhanced winching control.
- Ergonomic clutch handle.
- Three-stage planetary gear train for smooth, efficient operation.

- All-metal gear housing and gears.
- Fully sealed motor and drive train keep the elements out.
- Weather sealed corded remote and dash mounted switch.

- Limited lifetime warranty for mechanical components and 3-year warranty for electrical components.
- EC compliant.

WARN PROVANTAGE 4500-S WINCH

- Pulling strength capability of 4,500 lb (2,041 kg).
- 50 ft. of 7/32" (15.2 m of 5.5 mm) synthetic rope.
- Double-powder-coated hawse fairlead.
- Winch Electrical Harness (715003093) required for installation.

Traxter, Traxter MAX

715002941

\$XXXX



WARN PROVANTAGE 4500 WINCH

- Pulling strength capability of 4,500 lb (2,041 kg).
- 55 ft. of 7/32" (16.8 m of 5.5 mm) wire steel cable.
- Roller fairlead.
- Winch Electrical Harness (715003093) required for installation.

Traxter, Traxter MAX

715002425

\$XXXX



CAN-AM TERRA BY SUPERWINCH⁺

- Ergonomic clutch handle.
- Rugged all-steel gears and bushings for more torque and durability.

- Automatic 100% load-holding brake.
- Sealed solenoid for all-weather protection.

- Weather sealed corded remote and dash mounted switch.
- EC compliant.

CAN-AM TERRA 45 WINCH BY SUPERWINCH

- Pulling strength capability of 4,500 lb (2,041 kg).
- 47 ft. of 1/4" (14.3 m of 6.3 mm) wire steel cable.
- Heavy-duty 4-way roller fairlead.
- Winch Electrical Harness (715003093) required for installation.

Traxter, Traxter MAX

715002838

\$XXXX



CAN-AM TERRA 45SR BY SUPERWINCH

- Pulling strength capability of 4,500 lb (2,041kg).
- 50' of 3/16" (15.2 m of 4.8 mm) synthetic rope.
- Corrosion-proof aluminum hawse fairlead.
- Winch Electrical Harness (715003093) required for installation.

Traxter, Traxter MAX

715004446

\$XXXX



Some products shown may not be available or homologated in your country. Contact your BRP dealer for local details.



REMOVABLE WINCH MOUNTING KIT

- Allows to remove your winch when needed.
- Use in combination with the Multimount Winch Harness (710004869 or 710005082 for Traxter MAX) to quickly and conveniently relocate a front-mounted winch to the rear of the vehicle.
- Not compatible for use with the Lower Front Receiver Hitch.
- Requires Higher Front Receiver Hitch (715003109).

Traxter, Traxter MAX
715001652

\$XXXX



LOWER FRONT RECEIVER HITCH

- Heavy-duty 1,500 lb (680 kg) towing capacity 2" (5 cm) receiver hitch.
- Expand and enhance functionality by pairing it with Higher Front Receiver Hitch (715003109) and Removable Winch Mounting Kit (715001652 (need to relocate winch from its standard mounting position)).

Traxter, Traxter MAX
715002519

\$XXXX



HIGHER FRONT RECEIVER HITCH

- Heavy-duty 1,500 lb (680 kg) towing capacity 2" (5 cm) receiver hitch.
- No need to relocate winch from its standard mounting position.

Traxter, Traxter MAX
715003109

\$XXXX



DROP TOW BAR

- Sturdy 2" (5 cm) ball-less tow bar.
- Conveniently set at standard trailering height.
- Requires Higher Front Receiver Hitch (715003109).

Traxter, Traxter MAX
715002521

\$XXXX



WINCH ELECTRICAL HARNESS

- (Not illustrated)
- Required to install a winch on base and DPS models.

Traxter, Traxter MAX
715003093

\$XXXX

MULTIMOUNT WINCH HARNESS

- (Not illustrated)
- Converts Removable Winch Mounting Kit (715001652) into a practical multimount winch kit.

Traxter
710004869

\$XXXX

Traxter MAX
710005082

\$XXXX

RUBBER RECEIVER PLUG

- Rubber cap for 2" (5 cm) Receiver Hitch.

705204503

\$XXXX



SYNTHETIC WINCH CABLE

- 50' of 7/32" (15.2 m of 5.5 mm) synthetic cable for Warn winch.
- Warn Hawse Fairlead (705204567) is required when upgrading to a synthetic cable to avoid damage and premature wear of the cable.

With Warn winch

715001118

\$XXXX

- 50 ft. of 3/16" (15.2 m of 4.8 mm) synthetic cable for SuperWinch winches.
- SuperWinch Hawse Fairlead (715004449) required when upgrading to a synthetic cable to avoid premature cable damage and wear.

With SuperWinch winch

715004448

\$XXXX



SYNTHETIC CABLE EXTENSION

- Lightweight 1/4" (6.3 mm) diameter, easy to handle and won't rattle in cargo box.
- Easily attaches to winch cable to provide additional 50' (15.2 m) of distance.
- 4,500 lb (2,041 kg) single line capacity.

715001120

\$XXXX



CARGO BED WINCH

- Allows you to pull heavy loads into the cargo box easily.
- Perfect for hunting applications when it comes to loading game.
- Includes support base made of heavy-duty 2" (5 cm) steel tubing, winch and weather-sealed corded remote.
- 750 lb maximum pulling capacity.
- Electronic security module to prevent vehicle damage that could occur if loaded vehicle exceeds manufacturer's gross weight rating.
- Adaptor Kit (715004709) required for installation with Gear Rail Adaptor.

Traxter, Traxter MAX

715003268

\$XXXX



SUPERWINCH HAWSE FAIRLEAD

- A must when upgrading your winch with a synthetic cable, this corrosion-proof aluminum hawse fairlead will prevent the cable from snapping in a corner of a roller fairlead and from wearing prematurely due to the rough surface of the worn roller guide.
- Must be used with synthetic cables only.

With SuperWinch

715004449

\$XXXX



WARN HAWSE FAIRLEAD

- Double-powder-coated construction.
- Required to use the Synthetic Winch Cable (715001118) on Warn winches.
- To be used with synthetic winch cables only.

705204567

\$XXXX



WIRED REMOTE CONTROL

- This kit allows winch owners to add the hand-held remote to vehicles with a stock winch.
- Works in conjunction with the mini-rocker switch.
- Harness 710004823 is required to use remote control on a vehicle with a factory installed winch.
- EC compliant.

With SuperWinch winch

710004887

\$XXXX

With Warn winch

710001002

\$XXXX



ROLLER FAIRLEAD

- Suggested when changing the wire rope.
- Heavy-duty replacement fairlead for winches.

With Warn winch

715001119

\$XXXX

With SuperWinch winch

710004822

\$XXXX



REPLACEMENT WIRE ROPE

- 55' of 7/32" (16.8 m of 5.5 mm) wire rope for Warn winch kit.
- 7,500 lb (2,041kg) pulling strength.

With Warn winch

715001117

\$XXXX

- 47 ft. of 1/4" (14.3 m of 6.3 mm) wire rope.
- 4,500 lb (2,041 kg) pulling strength.

With SuperWinch winch

705011595

\$XXXX



WIRELESS REMOTE CONTROL

- The system is quick and easy to install, thanks to a wiring harness with an integrated antenna and all necessary mounting hardware.
- Allows you to operate your winch from anywhere within a 50' (15.2 m) radius, increasing your recovery options.
- All components are weatherproof.

With Warn winch

715002542

\$XXXX



FRONT & REAR HITCH DRAWBAR

- Standard on 2" (5 cm) receiver hitch.
- It offers 1,300 lb (590 kg) of towing capacity.
- Hitch ball not included.

Traxter, Traxter MAX

715000972

\$XXXX

European Version

- Drawbar with 2" (50 mm) hitch ball.
- 715001473
- 705206264 (T Homologated)





NEW X MR / XT-P BOLSTER SEATS

- Bolster seat upgrade gives occupants additional support and comfort for recreational riding.
- Features added side padding and redesigned profile to help you control and enjoy your side-by-side vehicle to the fullest.
- Reinforced seat skin.
- Compatible with rear seat on MAX models.
- Not compatible with Heated Seat Covers.
- Available in Black/Brown and Black/Red coloring.
- Standard on Traxter X mr and XT-P models.

Traxter, Traxter MAX

- 715004363 • Black / Can-Am Red
- 715004678 • Black / Brown

\$XXXX



ADJUSTABLE DRIVER'S SEAT

- Driver seat upgrade that delivers an added 3 in. (8 cm) of forward/rearward adjustability for increased comfort and facilitated ingress / egress.
- Standard feature on XT, XT Cab and Mossy Oak Hunting Edition models.

Traxter, Traxter MAX

715004230

\$XXXX

INCREASE COMFORT WITH 3 EXTRA INCHES OF TO & FRO ADJUSTMENT



S3
FOR *can-am*

GET THE RIGHT HEIGHT WITH S3'S DURABLE RAISED A-ARMS MADE TO STAND APART

S3
FOR *can-am*

S3 FRONT HIGH CLEARANCE A-ARM

- Prevents A-arm damage over rough terrain.
- Preserves factory ride quality and turning radius without reducing performance.
- Not compatible with Apache 360 LT Track System and Front A-Arm Protectors.
- "S3 for Can-Am" branded.

Traxter (except XT Cab 2018 & up, X mr models),
Traxter MAX (except XT Cab 2018 & up, Lone Star Edition)

- 715003784 • Black
- 715005116 • Sunburst Yellow

\$XXXX



S3
FOR *can-am*

S3 REAR HIGH CLEARANCE A-ARM

- Prevents A-arm damage over rough terrain.
- Preserves factory ride quality and turning radius without reducing performance.
- Not compatible with Apache 360 LT Track System and Front A-Arm Protectors.
- "S3 for Can-Am" branded.

Traxter (except XT Cab 2018 & up, X mr models),
Traxter MAX (except XT Cab 2018 & up, Lone Star Edition)

- 715003785 • Black
- 715005118 • Sunburst Yellow

\$XXXX

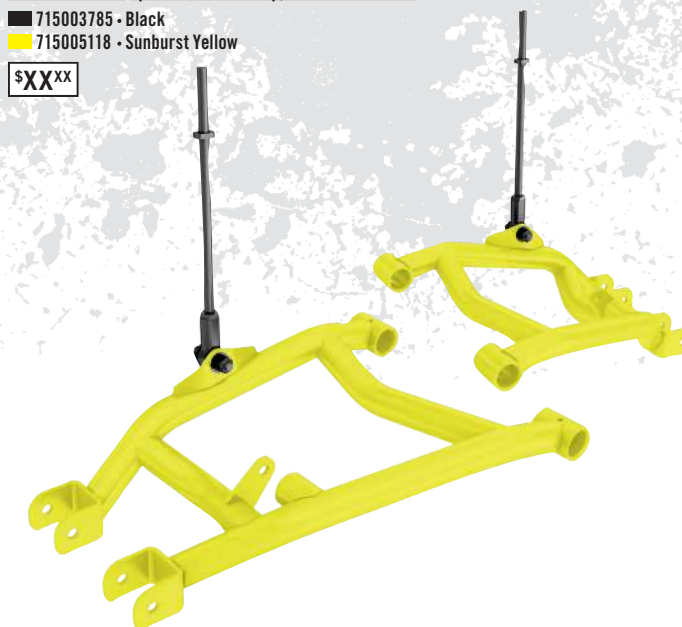

Some products shown may not be available or homologated in your country. Contact your BRP dealer for local details.



NEW SNORKEL KIT

- Raises point of engine and CVT air intakes so vehicle can be semi-submersed in water / mud without taking in water to the engine.
- Not compatible with Headache Racks, Gear Rail equipment, DragonFire Cargo Bed Roll Bar and Windshield Wiper, Rear Windows, Rear Panel and Washer Kit.

Traxter, Traxter MAX
715003727

\$XXXX

- Snorkel Extension Kit is available for roof level air intake and CVT exhaust.
- Adaptor for Snorkel Kit (715004414) and Sealed Air Box (707800714) are required for installation on 2017 and prior models.
- Standard on Traxter X mr models.

NEW SNORKEL EXTENSIONS

- Extend the Snorkel Kit (715003727) for roof engine and CVT air intake.
- Add aggressive look to your vehicle and help keep your intakes clear from mud, snow, dust, etc. in severe riding conditions.
- Not compatible with all rear panels and windows, Rear Cargo Light and roof-mounted Rear View Camera.
- Snorkel Kit (715003727) is required, except for X mr models.

Traxter, Traxter MAX
715004415

\$XXXX



NEW ADAPTOR FOR SNORKEL KIT

- (Not illustrated)
- Required for the installation of Snorkel Kit (715003727) on Traxter 2017 and prior models.
- Includes rear firewall for Snorkel Kit and hardware.
- Standard on Traxter 2018 and up models.

Traxter and Traxter MAX 2017 & prior
715004414

\$XXXX

FRONT HEAVY-DUTY SPRING

- This set of heavy-duty springs will stiffen your suspension.
- Perfect for reducing vehicle sag on heavy jobs like snow clearing or heavy load hauling.
- Sold in pairs.

Traxter
(Base & XT models only)
715002450

\$XXXX

Traxter MAX
(Base & XT models only)
715004280

\$XXXX



NEW SEALED AIR BOX

- (Not illustrated)
- Required when installing the Snorkel Kit (715003727) on Traxter and Traxter MAX 2017 and prior models.

Traxter, Traxter MAX
707800714

\$XXXX

NEW FOAM AIR FILTER BY TWIN AIR®

- The best choice for the harshest conditions.
- Multiple staged oiled filtering foam for superior dust retaining capacity with high air flow.
- Washable and reusable.

Traxter, Traxter MAX
715003630

\$XXXX



Some products shown may not be available or homologated in your country. Contact your BRP dealer for local details.

APACHE 360 LT TRACK SYSTEM

Highly engineered track system provides ultimate traction in harsh conditions for your Can-Am vehicle.

Heavy-duty components ensure reliability and the design offers excellent acceleration, turning, braking and side-hilling performance.

An innovative DPS module ensures speedometer accuracy and an optimized steering assist for use with tracks which make for a perfect control and riding ease.

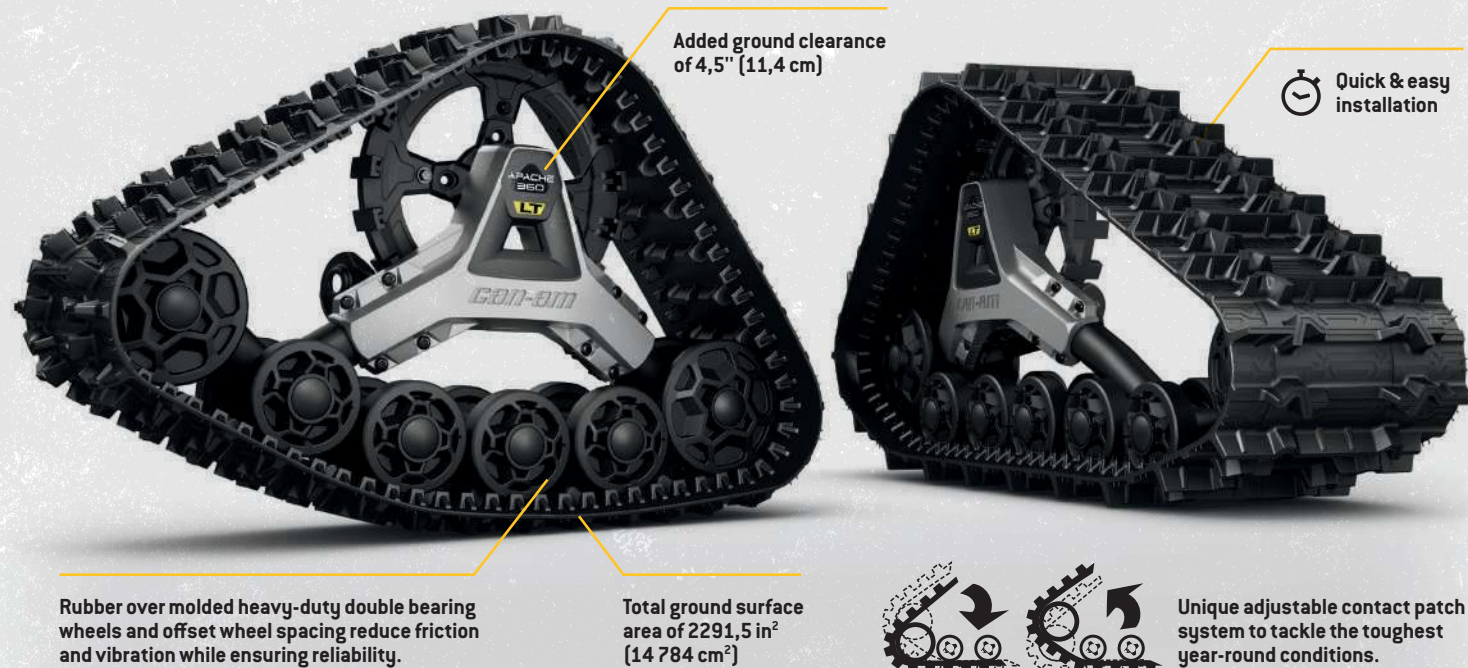

Added ground clearance of 4.5" (11.4 cm)

Quick & easy installation

Rubber over molded heavy-duty double bearing wheels and offset wheel spacing reduce friction and vibration while ensuring reliability.

Total ground surface area of 2291,5 in² (14 784 cm²)



Unique adjustable contact patch system to tackle the toughest year-round conditions.

APACHE™ 360 LT TRACK SYSTEM

- Multifunctional tracks designed to support heavy loads and to fit on most Can-Am off-road vehicles.
- Extra contact patch adjustment for better performance over rough terrain.
- Contact patch is 7 to 9% bigger than the Apache 360's.
- Average ground clearance increase of 4.5" (11.44 cm).
- 1" (2.5 cm) lugs in the front and 1.25" (3.2 cm) in the back.
- Apache 360 LT Mounting Kit is required.

Traxter, Traxter MAX
715003064

\$XXXX

YEAR-ROUND TRACKS

The APACHE 360 LT TRACK SYSTEM provides a unique adjustable contact patch that enables you to tackle the toughest conditions year round. You can choose a better attack angle in rough terrain or greater flotation in **deep snow**. Super versatile and ideal in springtime as well, when the **ground is muddy and soft**, allowing you to work and play on your terrain without damaging it. Some users love them in very **humid or swampy lands**, to help maintain better ground adhesion all season round.

NEW APACHE 360 LT MOUNTING KIT

- (Not illustrated)
 - Required to install Apache 360 LT Track System (715003064).
 - Track DPS Module and Air Intake Pre-Filter not included.
- Traxter XT Cab 2018 & up, Traxter XT Cab MAX 2018 & up, Traxter MAX Lone Star Edition and X mr models
715004832

\$XXXX

Traxter base, XT, XT MAX, Mossy Oak, XTP, XT Cab (2017 models only) & XT CAB MAX (2017 models only)
715004831

\$XXXX

TRACK DPS MODULE

- (Not illustrated)
- An innovative DPS module that ensures speedometer accuracy and optimized steering assist, which make for perfect track control and riding ease.
- Required to install the Apache and Backcountry Track Systems.
- Not sold in Europe.

715004707

\$XXXX

CVT AIR INTAKE PRE-FILTER

- Adds extra protection to your engine in harsh riding conditions.
- Helps keep air filter cleaner.
- Filter blocks particles larger than 0.007" (0.19 mm).
- Easy, tool-less installation.
- Necessary to maintain vehicle warranty when tracks are installed.
- Required to install the Apache and Backcountry Track Systems.

Traxter
(except X mr models),
Traxter MAX
715003483

\$XXXX



CVT AIR INTAKE RELOCATION KIT

- Relocates the CVT air intake protected in the cab area.
- Keeps the CVT air intake away from snow splashing from wheels or tracks.
- Highly recommended for track-equipped vehicles.

Traxter
(except X mr models),
Traxter MAX
715004183

\$XXXX



72" (183 CM) ALPINE FLEX PLOW KIT

- 72" (183 cm) blade made of flexible high-impact-resistant UHMW thermoplastic.
- Impressive flexibility prevents plow damage during accidental impacts.
- Impact absorption properties return blade to its original shape.
- Rearward release action greatly reduces transmission of impact to driver or unit.
- Fast and easy attach/detach mounting system.
- Conveniently-placed blade-turning mechanism eliminates having to bend down to adjust blade angle.
- High-pivot design keeps plow on surface.
- Compatible with all Alpine Flex Plow accessories to further enhance plow versatility.
- Includes Plow Roller Fairlead and cable saver limit switch.

THIS KIT INCLUDES:

72" (183 cm) Alpine Flex Plow (715001972)
Alpine Flex Plow Push Frame (715002461)
Alpine Flex Plow Mounting Kit (715002460)

Traxter, Traxter MAX
715003108

\$XXXX



ALPINE FLEX PLOW KIT shown with the following accessories:

8" (20 cm) Alpine Flex Plow Extensions (715001385)
Alpine Flex Drift Cutter (715001386)
Alpine Flex Plow Edge Markers (715001388)

ALPINE FLEX PLOW ACCESSORIES

ALPINE FLEX PLOW PUSH FRAME EXTENSION

- (Not illustrated)
- Extension for Alpine Flex Plow Push Frame for use with the Apache 360 LT Track System.

Traxter, Traxter MAX
715001973

\$XXXX

8" (20 CM) ALPINE FLEX PLOW EXTENSIONS

- These conveniently extend your Alpine Flex Plow.

Alpine Flex Plow
715001385

\$XXXX

ALPINE FLEX PLOW RUBBER FLAP

- Keeps snow away from the driver.
- Minimizes snow flowing over plow.
- Increases snow rolling effect.

72" (183 cm) Alpine Flex Plow

715002117

\$XXXX

ALPINE FLEX WEAR BLADE (PLASTIC)

- Flexible UHMW plastic construction won't scratch your driveway.
- Replaces stock wear blade.

72" (183 cm) Alpine Flex Plow

715002120

\$XXXX

ALPINE FLEX WEAR BLADE (STEEL)

- Long-lasting wear blade that provides a sharper cut.
- Replaces stock wear blade.

72" (183 cm) Alpine Flex Plow

715002121

\$XXXX

ALPINE FLEX DRIFT CUTTER

- Keeps snow securely in the plow.
- Fits on either left or right side.
- Sold individually.
- Requires 8" (20 cm) Alpine Flex Plow Extensions (715001385).

Alpine Flex Plow

715001386

\$XXXX

ALPINE FLEX PLOW EDGE MARKERS

- For a more accurate view of the width of your plow so you avoid damaging your curb, your car or your house.

Alpine Flex Plow

715001388

\$XXXX

72" (183 CM) SUPER-DUTY PLOW KIT

- A comprehensive plow system with manual lift and angling.
- Ultra-durable 72" (183 cm) blade made of 12-gauge steel with integrated reinforcement and heavy-duty push tubes to tackle the most demanding jobs.
- Requires a winch for raising and lowering.
- Convenient disconnect system for quick and easy installation or removal.
- Front mount provides minimum 11" (28 cm) lift distance.

THIS KIT INCLUDES:

- 72" (183 cm) Super-Duty Plow (715001292)
- Super-Duty Plow Push Frame (715001293)
- Super-Duty Plow Mounting Kit (715002731)

Traxter, Traxter MAX

715003416

\$XXX



SUPER-DUTY PLOW KIT shown with the following accessories:

- Plow Rubber Flap (715001219)
- Plow Drift Cutter (715001218)
- Plow Edge Markers (715001216)

SUPER-DUTY PLOW ACCESSORIES

SUPER-DUTY PLOW HYDRAULIC ANGLING KIT

- Allows you to have full up/down and left/right plow control at your fingertips.
- Pre-assembled, it comes with everything you need to turn your Super-Duty Plow into a quick, easy-to-control unit from the driver's seat.
- Using one hand to control all plow motions with the supplied joystick will allow you to easily concentrate and manage your plowing tasks.
- With this commercial grade kit, you will send snow exactly where you want reliably all winter long.
- Winch and plow sold separately.

Traxter, Traxter MAX

715002840

\$XXX



Dual cylinders hydraulic



Electric hydraulic unit

PLOW BLADE EXTENSIONS

- Side extensions for widening your plow blade by 6" (15 cm) on each side.
- Include rubber flaps for extension parts.
- Sold in pairs.

Super-Duty Plow

715001217

\$XXX



WARN[†] PLOW ROLLER FAIRLEAD

- Larger diameter lower roller reduces wear on wire rope for plow application.
- For use with Super-Duty Plow.

Super-Duty Plow

715001223

\$XXX



SUPER-DUTY PLOW PUSH FRAME EXTENSION

- Extension to use the Super-Duty Plow with the Apache 360 LT Track System.
- Comes with Plow Magnetic Switch (715001995) and Plow Pulley (715002042).
- Requires Front Bumper or Front Accessory Bar for installation.

Super-Duty Plow

715001221 • Black

\$XXX

PLOW EDGE MARKERS

- For a more accurate view of the width of your plow.
- Allows you to work closely around objects.

Super-Duty Plow

715001216

\$XXX

PLOW DRIFT CUTTER

- Keeps snow securely in the plow.
- Allows you to cut a cleaner pass.
- Sold individually.

Super-Duty Plow

715001218

\$XXX

PLOW RUBBER FLAP

- Keeps snow away from the driver and helps snow to roll in front of the plow.

Super-Duty Plow

715001219

\$XXX

PLOW PULLEY

- (Not illustrated)
- For use with the Super-Duty Plow.
- Helps winching efficiency.
- Requires Front XT Bumper.

Super-Duty Plow

715002042

\$XXX

PLOW MAGNETIC SWITCH

- (Not illustrated)
- Magnetic switch that stops the winch to prevent cable, winch and frame damage.
- For use with Super-Duty Plow.

Super-Duty Plow

715001995

\$XXX

TRAILERING COVER

- Heavy-duty canvas made of UV-resistant solution-dyed polyester.
- Inner soft liner protects windshield and colored panels from abrasion.
- All high-abrasion areas are reinforced with a double canvas layer.
- Weather-resistant trailering cover protects your vehicle during storage and transportation.

- Opening for fuel cap and cabin access on passenger side.
- Quick and easy installation.
- Designed to perfectly fit your vehicle with or without Can-Am accessories.

Traxter

715001369

715004453 • European Version

\$XXX

Traxter MAX

715004454

\$XXX



NEW BOLT-ON[†] RETRACTABLE RATCHETING TIE-DOWNS

- Perfect for transporting your powersport vehicle or securing loads.
- Mounts easily: Bolts on any flat surface (e.g. truck bed or frame).
- 1" x 6' (2.5 cm x 1.8 m) tie-down strap with heavy-duty stitching that delivers a 500 lb (226 kg) working load strength and 1,500 lb (680 kg) break strength.
- Convenient retractable push button automatically slackens, spools and stores away strap, while the ratchet mechanism tightens the strap snugly to secure your vehicle or load into place.
- Rubber ratcheting handle provides firm grip, and the hook is vinyl coated to protect whatever surface it hooks into.
- Sold in pairs.

295100737

\$XXX



RATCHET TIE-DOWNS

- 400 lb (181 kg) safe working load.
- 1" x 10' (2.5 cm x 3 m) strap with Sea-Do, Ski-Do and Can-Am logos.
- Deluxe ratchet with rubber handle.
- Coated S hooks.
- Pack of 2.

860200447 • Black/Grey

\$XXX



TIRES

ACCESSORY TIRES

ZILLA TIRE BY MAXXIS[®]

- Sold individually.

Front
27" x 10" x 14"
705401302

\$XXX

Rear
27" x 12" x 14"
705501703

\$XXX



REAR TIRE CHAINS

- Improve your traction in mud and snow.
- Sold in pairs.

27" x 11" x 14"
715003839

\$XXX

29" x 9" x 14"
71500225

\$XXX



*Consult your operator's guide/owner's manual for proper tire type and rim sizing. Improper tire type and rim selection may affect vehicle handling. Check with your local authorities for proper regulation.

Some products shown may not be available or homologated in your country. Contact your BRP dealer for local details.

WITHOUT TRACTION,
THERE'S NOTHING—
FIT THE BEST TIRES
AND WHEELS ON
YOUR TRAXTER
AND SEE ALL IT CAN DO



OEM TIRES

NEW ITP CRYPTID

- Graduated lug height and paddle-like shoulder configuration provide maximum side bite for climbing in and out of the mud without compromising ride comfort on trails and hard pack.
- 6-ply rated.

Traxter X mr

Front
705402096 • 30" x 9" x 14"
Rear
705502621 • 30" x 11" x 14"



MAXXIS BIGHORN 2.0 TIRE

Traxter (XT, XT Cab)

Front - 27" x 9" x 14"
705401377

\$XXXX

705400961 • €€

Rear - 27" x 11" x 14"
705502019

\$XXXX

705501295 • €€

Traxter

Front - 27" x 9" x 12"
705401385

\$XXXX

705401386 • €€

Rear - 27" x 11" x 12"
705501817

\$XXXX

705501818 • €€

Front - 28" x 9" x 14"
705401592

\$XXXX

Rear - 28" x 11" x 14"
705502144

\$XXXX



MAXXIS CORONADO

- Compliant with European T regulations.
- Traxter Convenience & PRO

Front
27" x 9" x 14"
705402058

\$XXXX

Rear
27" x 11" x 14"
705502576

\$XXXX



MAXXIS M923J / M924J

Traxter (Base & DPS models only)

Front - 25" x 8" x 12"
705401658

\$XXXX

Rear - 25" x 10" x 12"
705502215

\$XXXX



OEM RIMS & BEADLOCKS

14" MAVERICK X DS RIM

- Black with clear coat aluminum rim.
- Choice of beadlock color (not included).
- Needs 16 bolts (250000435) for installing the beadlock.

Traxter, Traxter MAX

Front - 14" x 6.5" offset = 41 mm

705401594

\$XXXX

Rear - 14" x 8" offset = 51 mm

705502146

\$XXXX



12" RIM

- Black with clear coat aluminum rim.
- Choice of beadlock color (not included).
- Needs 16 bolts (250000435) for installing the beadlock.

Traxter, Traxter MAX

Front - 12" x 6" offset = 41 mm

705401678 - Black

\$XXXX

Rear - 12" x 7.5" offset = 51 mm

705502244 - Black

\$XXXX



14" X DS BEADLOCK

- Cast aluminum beadlock.
- Must be installed on Front Rim (705401594) and Rear Rim (705502146).

Traxter, Traxter MAX

705401586 - Manta Green

705401702 - Octane Blue

705401837 - Can-Am Red

705401840 - Black

\$XXXX

NOTE: Matching Nuts - 250100100 / Matching Cap - 705400928

12" MAVERICK BEADLOCK

- Cast aluminum beadlock.
- Must be installed on Front Rim (705401678) and Rear Rim (705502244).

Traxter, Traxter MAX

705401445 - Can-Am Red

705401543 - Orange Crush

705401329 - Yellow

705401695 - Octane Blue

\$XXXX

NOTE: Matching Nuts - 250100100 / Matching Cap - 705400928

OUTLANDER X MR AND TRAXTER RIM

- Cast aluminum rim with trend setting explosive styling so you can ride - and look - like a trailblazer.

Traxter, Traxter MAX (front wheels)

Front - 14" x 6.5" offset = 10 mm

705401848 - Black and machined

705401849 - Black

\$XXXX

Traxter, Traxter MAX (rear wheels)

Rear - 14" x 8.5" offset = 23 mm

705502397 - Black and machined

705502398 - Black

\$XXXX



NOTE: Matching Nuts - 250100100 Black, 250100082 Chrome / Matching Cap - 705401541

LIMITED 14" RIM

- Premium cast aluminum rim.
- Black with machined face.
- Sold individually.
- Standard on Limited model.

Traxter, Traxter MAX

Front - 14" x 7" offset = 41 mm

705401380 - Silver/Black

\$XXXX

Rear - 14" x 8.5" offset = 51 mm

705501813 - Silver/Black

\$XXXX



TRAXTER XT RIM

(Not illustrated)

Front - 14" x 7" offset = 41 mm

705401564 - Black

705401559 - Silver and machined

705401563 - Black and machined

\$XXXX

Rear - 14" x 8.5" offset = 51 mm

705502103 - Black

705502101 - Silver and machined

705502102 - Black and machined

\$XXXX

NOTE: Matching Nuts - 250100100 Black, 250100082 Chrome / Matching Cap - 705401541

ACCESSORY RIMS

LOCKOUT 393 14" RIM BY VISION®

- Sold individually.
- Matching Cap (705401362), Matching Nuts (250100100).

Front - 14" x 7" Bolt circle pattern: 4/136 mm
Wheel offset: 4 + 3

705401363

\$XXXX

Rear - 14" x 8" Bolt circle pattern: 4/136 mm

Wheel offset: 4 + 4

705501787

\$XXXX



XT 14" RIM

- Premium cast aluminum rim.
- Sold individually.
- Standard on XT Camo models.

Traxter, Traxter MAX

Front - 14" x 7" offset = 41 mm

705401379 - Black

\$XXXX

705401378

Silver with clear coat

\$XXXX

705401379 - Black

705501814 - Black

705501812

Silver with clear coat

\$XXXX

NOTE: Matching Nuts - 250100100 Black & 250100082 Chrome / Matching Cap - 705400680 Black



*Consult your operator's guide/owner's manual for proper tire type and rim sizing. Improper tire type and rim selection may affect vehicle handling. Check with your local authorities for proper regulation.

Some products shown may not be available or homologated in your country. Contact your BRP dealer for local details.

SPORTSWEAR & RIDING GEAR



CAN-AM SPORTSWEAR

NEW ZIPPED HOODIE

- Full-zip hooded sweatshirt.
 - Ribbed waistband and cuffs.
 - Can-Am print in hood liner.
 - High-density logo at front.
 - 2 hand warmer pockets.
 - Woven label at pockets.
- 60% Cotton, 40% Polyester Fleece
454080 - S, M, L, XL, 2XL, 3XL - Blue (80), Black (90)

\$XXXX



NEW CAN-AM PULLOVER HOODIE

- Lightweight cotton hoodie.
 - Printed logo at sleeve.
 - Woven label at hem.
- 60% Cotton, 40% Polyester
454079 - S, M, L, XL, 2XL, 3XL - Charcoal Grey (07)

\$XXXX



NEW TECHNICIAN SHIRT

- Yarn dyed twill shirt.
 - Patch logos at front.
 - Pleat at center back.
 - Chest pocket with zipper.
- 60% Cotton, 40% Polyester
454074
S, M, L, XL, 2XL, 3XL - Blue (80), Black (90)

\$XXXX



NEW LONG SLEEVE ORIGINAL TEE

- Cotton tee with discharge print logo and woven label at back.
- 100% Cotton
454085
S, M, L, XL, 2XL, 3XL - White (01), Black (90)

\$XXXX



NEW ORIGINAL TEE

• Cotton tee with discharge print logo and woven label at back.
100% Cotton
454068 - XS, S, M, L, XL, 2XL, 3XL - White (01), Black (90)

\$XXXX



NEW INTRUSION TEE

• Cotton tee with screen print logo and woven label at back.
100% Cotton
447373 - XS, S, M, L, XL, 2XL, 3XL - Black (90), Amber (95)

\$XXXX



NEW X-TEAM TEE

• Cotton tee with screen print logo at front and back.
• Woven label at side.
100% Cotton
454069 - XS, S, M, L, XL, 2XL, 3XL - Blue (80), Black (90)

\$XXXX



NEW LADIES' ORIGINAL TEE

• Cotton tee with discharge print logo and woven label at back.
• Feminine cut.
95% Cotton, 5% Spandex
454071
XS, S, M, L, XL, 2XL
White (01), Black (90)

\$XXXX



NEW LADIES' X-TEAM TEE

• Cotton tee with screenprint logo and woven label at side.
• Pocket at front.
95% Cotton, 5% Spandex
454070
XS, S, M, L, XL, 2XL
Turquoise (Aqua) (76), Black (90)

\$XXXX



NEW INTRUSION CAP

• Adjustable plastic strap.
• Cotton canvas at front.
• Embroidered logos at front.
• Mesh at back.
55% Cotton, 45% Polyester
447370 - One size
Charcoal Grey (07), Black (90)

\$XXXX



NEW INTRUSION FLAT CAP

• Adjustable plastic strap.
• Cotton canvas.
• Logo embroidered at front.
• Woven label at back.
• Screen print under brim.
100% Cotton
447383 - One size
Blue (80)

\$XXXX



NEW FLAT EDGE CAP

• Adjustable plastic strap.
• Flat peak.
• Cotton canvas at front.
• Mesh at back.
55% Cotton, 45% Polyester
447646 - One size
Black (90)

\$XXXX



NEW CLASSIC CAP

• Adjustable plastic strap.
• Embroidered 3D logo at front.
• Woven label at back.
• Screen print under brim.
100% Cotton
448522 - One size-Grey (09), Red (30), Blue (80), Navy (89), Black (90)

\$XXXX



NEW ADVENTURE TEAM JERSEY

• Quick-dry, antibacterial moisture-wicking fabric.
• Extended back for coverage while riding.
• Mesh fabric for extra ventilation underarms.
• Non-fading sublimated graphics
• Rib cuffs.
100% Polyester
454072 - S, M, L, XL, 2XL, 3XL - Grey (09), Red (30)

\$XXXX



NEW X-RACE JERSEY

• Ultralight, quick-dry, antibacterial and moisture-wicking fabric.
• Mesh fabric for maximum breathability.
• Extended back for coverage while riding.
• Non-fading sublimated graphics.
• Rib cuffs.
100% Polyester
454073 - S, M, L, XL, 2XL, 3XL - Charcoal Grey (07), Blue (80)

\$XXXX



NEW LADIES' TEAM JERSEY

• Semi-fitted cut specifically designed for ladies.
• Quick-dry, antibacterial, moisture-wicking fabric for maximum comfort.
• Mesh fabric for extra ventilation underarms.
• Rib cuff.
• Non-fading sublimated graphics.
90% Polyester, 10% Spandex
454134 - XS, S, M, L, XL, 2XL
Grey (09), Teal (74)

\$XXXX



MOSSY OAK CAMO JERSEY

• Ultralight, quick-dry, antibacterial moisture-wicking fabric.
• Extended back improves coverage.
• Non-fade sublimated Mossy Oak Break-Up Country Camo fabric matches ATV/Side-by-side pattern.
100% Polyester
286606 - M, L, XL, 2XL, 3XL
Mossy Oak Break-Up Country Camo (37)

\$XXXX



Some products shown may not be available or homologated in your country. Contact your BRP dealer for local details.

MUD JACKET

- 100% waterproof PVC.
- Electronically-welded seams.
- Underarm and rear vent panels.
- 2 hand pockets.
- Elastic cuffs.
- Drawstring hood and hem.

Polyvinyl Chloride (PVC)
286676 • S, M, L, XL, 2XL
Clear (00), Matte Black (93)

\$XXXX



MUD PANTS

- Oversized pants made of 100% waterproof PVC.
- Electronically-welded seams.
- Strategically placed ventilation.
- Side openings at bottom leg.

Polyvinyl Chloride (PVC)
286128 • S, M, L, XL, 2XL
Clear (00), Matte Black (93)

\$XXXX



JACKETS & PANTS

RPM

MEN'S RIDING JACKET

- Highly resistant, Teflon™-treated with RPM waterproof and breathable technology.
- Double-stitch construction throughout.
- Critical seams sealed.
- Double front flap and adjustable wrists and hem.
- Small opening at left shoulder for hydration pack water delivery tube (not included).
- Shaped sleeves.

- Large ventilation at chest, sleeves and back for maximum breathability and good airflow.
- Sleeves can be stored in lower large back pocket.
- Multiple pockets.
- Mesh lining.
- Reflective details.
- Jacket-to-pants connector.

100% Nylon

286390 • XS, S, M, L, XL, 2XL, 3XL • Yellow (10), Camo (37), Black (90)

\$XXXX



You can zip off sleeves to wear this jacket as a vest in warmer conditions and sleeves can be stored in lower back large pocket.

RPM

MEN'S ADVENTURE PANTS

- Lightweight durable pants with RPM waterproof and breathable technology.
- Stretch waterproof panel at crotch and upper back for ease of movement.
- Triple stitched construction at crotch.
- Critical seams sealed.
- Shaped knees with darts.
- Binding hem at cuff for reinforcement.
- Storm gaiters at bottom opening.
- Velcro™ side waist adjustment.
- Side leg 2-way zipper to facilitate exit.
- Jacket-to-pants connector.
- Mesh lining.
- Belt loops.

100% Nylon

286391 • 28, 30, 32, 34, 36, 38, 40, 42, 44 • Yellow (10), Camo (37)

\$XXXX



RPM

MOSSY OAK CAMO JACKET

- Stealthy-silent waterproof Mossy Oak Break-Up Country Camo fabric matches ATV/Side-by-side pattern.
- Fully-sealed seams.
- Sleeve and side seam ventilation evacuates moisture.
- Detachable hood and molded visor with height-adjustment drawstring.
- Adjustable cuff with hook-and-loop tab.
- Chest pockets, 2 expandable lower pockets, plus hand-warmer pockets.
- Designed for backpack wear with easy access to vents and pockets.
- Articulated elbow with longer back tailored for riding position.

100% Polyester

286544 • M, L, XL, 2XL
Mossy Oak Break-Up Country Camo (37)

\$XXXX



RPM

MOSSY OAK CAMO PANTS

- Stealthy-silent waterproof Mossy Oak Break-Up Country Camo fabric matches ATV/Side-by-side pattern.
- Fully-sealed seams.
- Dual easy-access cargo pockets.
- Knee-high side zipper.
- Thinner knee and seat foam for added comfort.
- Removable suspenders.
- Articulated knee and raised back waist ideal for riding position.
- Brushed tricot lining.
- Belt loops.
- Adjustable bottom leg system.

100% Polyester

286545 • M, L, XL, 2XL
Mossy Oak Break-Up Country Camo (37)

\$XXXX



RANCH HEAVY DUTY JACKET

- Heavy-duty stain and water-repellent cotton canvas.
- Lightly insulated.
- Rear armhole gusset enhances mobility.
- Shaped sleeves and back tail for riding comfort.
- Multiple pockets.

100% Cotton

Insulation: 100% Polyester

286551 • S, M, L, XL, 2XL, 3XL
Brown (04)

\$XXXX



RANCH HEAVY DUTY PANTS

- Heavy-duty stain and water-repellent cotton canvas.
- 2 side-leg cargo pockets.
- Belt loops.
- Pre-shaped legs.

100% Cotton

286556 • 28, 30, 32, 34, 36, 38, 40, 42, 44 • Brown (04)

\$XXXX



RPM

STORM JACKET

- RPM MAX waterproof, windproof and breathable technology.
- Windproof DWR-treated polyester fabric.
- Fully-sealed seams.
- Double front-flap with interior rain gutter.
- Minimalist design helps repel mud and water.
- Zippered pockets at left chest and waist.
- Inner pocket with Velcro closure.
- Gussets at back armhole for ease of movement.
- Pre-shaped sleeves.
- Can-Am print at front.
- Embossed Can-Am patch at back.
- Adjustable wrists and hem.

100% Polyester

286611 • M, L, XL, 2XL, 3XL • Khaki (05)

\$XXXX



RPM

STORM PANTS

- RPM MAX waterproof, windproof and breathable technology.
- Windproof DWR-treated polyester fabric.
- Fully-sealed seams.
- Zippered pocket on left leg.
- Adjustable suspenders with bib.
- Y-shape strap designed to stay securely on shoulders.
- Storm gaiters at bottom opening.
- Self-fabric gusset at crotch keeps out water and mud.
- Pre-shaped legs.
- Can-Am print at right leg.
- Reinforced inner-leg fabric.

100% Polyester

286612 • S, L, XL, 2XL, 3XL • Khaki (05)

\$XXXX



CAN-AM WINDPROOF JACKET

- Windproof DWR-treated nylon.
- Adjusted fit.
- Sealed critical seams.
- Hand pockets, plus interior Napoleon pocket.
- Large high-visibility reflective stripes on shoulders.
- Adjustable wrists and hem.
- Jacket-pant connector.
- Pre-shaped sleeves.
- Can-Am branded on front-rear.

100% Nylon
286578 • XS, S, M, L, XL, 2XL, 3XL
Black (90)

\$XXX



CAN-AM WINDPROOF PANTS

- Windproof DWR-treated nylon.
- Adjusted fit.
- Durable 500-denier seat fabric.
- Sealed critical seams.
- Thigh pocket.
- Elasticized waist with belt loop.
- Fitted to be worn over pants.
- Pre-shaped legs.
- Can-Am branded pocket.

100% Nylon
286579 • 28, 30, 32, 34, 36, 38, 40, 42, 44
Black (90)

\$XXX



NEW WINTER RIDING JACKET

- Robust textured fabric featuring RPM waterproof, windproof and breathable technology.
- Critical seams sealed for added protection.
- Vents at underarm to enhance moisture evacuation during rigorous riding or mild weather.
- 2 waist pockets and 1 Napoleon pocket.
- Cap inner pockets.
- Cold-blocking front flap with insulated under flap uniquely designed for off-road riding windproofness.
- Powder skirt to keep wind, cold and snow from entering.
- Reflective details.
- Micro-polyester at collar and micro-fleece integrated inner wrists.
- Inside front and back panels lined with micro-fleece to add warmth and comfort.
- Easy-access collar adjustment on both sides.
- Bottom and wrist adjustments.
- Can-Am print at front and on sleeve.
- Can-Am embroidery at back.

60% Polyester, 40% Nylon
Insulation: Primaloft Black
286609 • L, XL, 2XL, 3XL • Black (90)

\$XXX



NEW WINTER RIDING HIGHPANTS

- RPM waterproof, windproof and breathable technology.
- Intelligent combination of materials specifically adapted to winter riding.
- Critical seams sealed.
- Reinforced fabric at seat and knees.
- 3/4 length side zippers with adjustable hem.
- Reflective details.
- Storm gaiter with boot lace snap-on webbing to shield snow entry.
- Pre-shaped legs.
- Bib-style pants with high back and front to keep wind and snow out.
- Adjustable suspenders with Y-shape strap designed to stay securely on shoulders.
- Fleece-lined seat.

60% Polyester, 40% Nylon
Insulation: Primaloft Black
286610 • S, M, L, XL, 2XL, 3XL • Black (90)

\$XXX



LADIES' CROSS PANTS

- Lightweight durable pants with RPM waterproof and breathable technology.
- 500-denier waterproof nylon at seat and bottom inseam.
- Stretch fabric waistband.
- Critical seams sealed.
- Water-resistant thigh zipper vent.
- Hip pocket with zipper and flap.
- Jacket-to-pants connector.
- Binding hem at cuff for reinforcement.
- Storm gaiters at bottom opening.
- Shaped knees with darts.
- Mesh lining.
- Belt loops.

100% Nylon
286478 • 6, 8, 10, 12 • Black (90)

\$XXX



LADIES' WINTER RIDING HIGHPANTS

- RPM MAX waterproof, windproof and breathable technology.
- Technical, comfortable, versatile with feminine cut.
- All seams and logos sealed.
- 1000-denier nylon-lined seat, knees and inner legs.
- Polar-fleece lined seat and knees.
- Stretch-fleece bib.
- Drop seat design.
- Shaped knees.
- 2-way full-length side zippers.
- Adjustable waist.
- Hip pockets.
- Water-resistant zipper at right thigh pocket.
- Reflective details.

90% Nylon, 10% Polyester
Insulation: Primaloft Black
286460 • XS, S, M, L, 3XL • Matte Black (93)

\$XXX



CAN-AM RIDING BOOTS

- Rider-tough 20cm lace-up-style riding boots.
- VIBRAM® Bifida® outsoles for superior performance.
- COSMO® HydroGuard® waterproofing.
- Full-grain leather upper (waterproof nubuck in beige model).
- Removable Meramec® Ultron® insoles.
- Ultra-comfortable padded collar.

100% Leather
444197 • 7, 8, 9, 10, 11, 12, 13 • Beige (02), Black (90)

\$XXX

- High-gusseted tongue keeps out water and debris.
- Steel toe caps.
- Abrasion-resistant TPU toe protectors.
- Double heavy-duty stitching in higher-stress areas.
- Abrasion-resistant laces.



CAN-AM NEOPRENE MUD BOOTS

- 100% waterproof polyurethane boot.
- Neoprene upper for maximum flexibility while walking or riding.
- Lightweight and comfortable soft liner.
- Aggressive tread design for maximum grip on any surface.
- Excellent resistance to oils, grease and gasoline.

60% Polyurethane, 40% Neoprene
444196 • 8, 9, 10, 11, 12, 13
Black (90)

\$XXX

444201 • 8, 9, 10, 11, 12, 13
Next G-1 Vista Camo (37)

\$XXX



BALACLAVAS

MICRO-FLEECE BALACLAVA

- Stretch, antibacterial warming fleece fabric with brushed inner surface.
- Flatlocked seams prevent skin chafing.

92% Polyester, 8% Spandex
447565 • One size • Black (90)

\$XXX



TECHNICAL BALACLAVA

- Micro-fleece balaclava with strategically placed mesh for breathability.
- Windproof neck bib.
- Higher at back of neck for increased motion range.
- Flatlocked seams prevent skin chafing.

92% Polyester, 8% Spandex
445950 • One size • Black (90)

\$XXX



BASIC BALACLAVA

- Designed for warmth, dryness and comfort.
- Flatlocked seams prevent skin chafing.
- 80% Nylon, 20% Spandex

447449 • One size • Black (90)

\$XXX



NECK AND BODY CORE PROTECTION

WINDPROOF LAYER

- Coverage for your crucial body core.
- Windproof, warm and breathable layer.
- Stretch fabric and unrestricted arm movement.
- Zipper on shoulder for easy slip on/off, even with a helmet.
- Flatlock seams to prevent skin chafing.

100% Polyester
286348 • S, M, L, XL, 2XL • Black (90)

\$XXX



NECK GAITER

- Anti-pilling fleece.
- Spandex binding for a better fit.

100% Polyester
286331 • One size • Black (90)

\$XXX



Some products shown may not be available or homologated in your country. Contact your BRP dealer for local details.



ENDURO DESIGNED FOR LONG RIDES AND HIGH ADVENTURE.

Features & Benefits

- Perfect for adventure riding, on or off the trails. The EX-2 offers the dual experience of riding with a visor helmet plus the look and advantages of an MX helmet.
- Advanced plastic composite shell.
- Lockable, multi-positions and anti-scratch visor.
- Interchangeable retractable sun visor.
- Removable aerodynamic peak.
- Ultra-comfort and washable Dri-Lex⁺ linings.
- Oversized chin deflector.
- Adjustable air vents and exhausts.

EX-2 ENDURO HELMET

Shell: Polycarbonate Composite
448466
XS, S, M, L, XL, 2XL
Black with graphics (94)

\$XXX

DOT ECE22.05



XP-3 SUPERLIGHT CROSS-STYLE HELMET: FEATURE-PACKED FOR EXCEPTIONAL PERFORMANCE, PROTECTION AND COMFORT.

Features & Benefits

- Premium shell construction using superlight fiberglass and impact absorbing EPS liner.
- Aero-tuned fully adjustable visor system.
- Custom stainless grille design.
- Front and rear hi-max air vent system to maximize cooling.
- Removable, washable and replaceable CoolMax[™] moisture-wicking liner.
- Lightweight double-D chin strap.
- Weight: ±1470 grams for size Large.
- Durable multi-colored clear coated graphics.
- Can-Am branded.
- Triple certified: DOT, ECE and SNELL M2015.

NEW XP-3 PRO X-RACE HELMET

Shell: Fiberglass
448537
XS, S, M, L, XL, 2XL
White (01), Gold (11)

\$XXX

DOT Snell ECE22.05



XP-3 X-RACE HELMET

• Durable multi-colored clear-coated graphics.
Shell: Fiberglass
448342 - ECE
XS, S, M, L, XL, 2XL
Yellow (10), Green (70)

\$XXX

DOT Snell ECE22.05



XC-4 PREMIUM LOOK & STYLE.

Features & Benefits

- Shell construction is super light polycarbonate with impact absorbing EPS liner.
- Fully adjustable visor system.
- Custom stainless grille design.
- Front and rear hi-max air vent system to maximize cooling.
- Removable, washable and replaceable moisture-wicking liner.
- Lightweight double-D chin strap.
- Weight: ±1470 grams for size Large.

NEW XC-4 MODERN HERITAGE HELMET

- Durable multi-colored clear coated graphics.
- Can-Am branded.

Shell: Polycarbonate Composite

448526 - XS, S, M, L, XL, 2XL
White (01), Grey (09)

\$XXX

DOT ECE22.05



XC-4 HELMET

Shell: Polycarbonate Composite
448255 - XS, S, M, L, XL, 2XL - Black (90)

\$XXX

DOT Snell



LADIES' XC-4 HELMET

- Durable multi-colored clear coated graphics.
- Winter breath deflector included.

Shell: Polycarbonate Composite

448397 - XS, S, M, L, XL, 2XL - Pink (36)

\$XXX

DOT ECE22.05



DUST MASKS

- Easily replaceable filters remove 99.9% of airborne dust, particles, pollen and odors.
- Made from soft yet durable neoprene material that fits snugly under helmets and goggles.
- XS/S fits most kids 12 and under, M/L fits most riders and XL/2XL fits larger frames (235+ lb).
- Includes 2 replacement filters and a small storing pouch.



NEW CAN-AM ORIGIN DUST MASK

• Convenient MP3 player pocket on the side.
448524
XS/S, M/L, XL/2XL
Black with graphics (94)

\$XXX



NEW CAN-AM VENTED DUST MASK

448525
XS/S, M/L, XL/2XL
Black (90)

\$XXX



CAN-AM X-RACE DUST MASK

448247
XS/S, M/L, XL/2XL
Yellow (10)

\$XXX

COMMUNICATION SYSTEM

NEW SENA 30K BLUETOOTH COMM SYSTEM

- Bluetooth headset that operates on Sena's Mesh Intercom[™] technology.
- The 30K has a new quick charge feature meaning just 20 minutes of charging gets riders an impressive 5 hours of Bluetooth intercom use, or 3 hours Mesh Intercom use.
- 2.4 GHz frequency, connecting to other riders in an entirely new way.
- Should one of the group's riders go out of range, the Mesh Intercom intelligently keeps the rest of the group in seamless communication, while actively searching to reconnect, should that rider come back within range.
- Using the private group mode, the 30K can pair in full duplex communication with up to 16 riders at a range up to 1.2 miles.
- Sena 30K Audio Multitasking technology allows you to have a conversation via Adaptive Mesh-Networking technology while simultaneously enjoying Bluetooth operations such as streaming smartphone music, taking or making phone calls, or listening to turn-by-turn GPS navigation.

Single Pack

448610
One size
Black (90)

\$XXX

Dual Pack

448611
One size
Black (90)

\$XXX





CAN-AM RACE SAND GOGGLES BY SCOTT

- No Fog¹ anti-fog lens treatment.
- 100% UV protected grey Lexan¹ lens.
- Dust catcher vent foam.
- Multi-layer face foam.
- Durable anti-slip strap.
- Tear-off and roll-off compatible (sold separately).
- Extra clear lens in the box.

448491 • One size • Black (90)

\$XXXX



CAN-AM ADVENTURE OVER THE GLASSES GOGGLES BY SCOTT

- Same great features as the Can-Am Adventure goggles, engineered to fit comfortably with prescription eyeglasses.

447901 • One size • Black (90)

\$XXXX



CAN-AM ADVENTURE GOGGLES BY SCOTT

- No Fog anti-fog lens treatment.
- Clear Lexan lens.
- Multi-layer face foam.
- Durable anti-slip strap.
- Tear-off and roll-off compatible (sold separately).

447900 • One size
White (01), Yellow (10), Black (90)

\$XXXX



CAN-AM TRAIL GOGGLES BY SCOTT

- 100% UV protected clear Lexan lens.
- Hypoallergenic super-soft face foam.
- Durable anti-slip strap.
- Tear-off and roll-off compatible (sold separately).

447899 • One size
White (01), Yellow (10), Black (90)

\$XXXX



CAN-AM WORKS FILM SYSTEM BY SCOTT

- 1 anti-stick replacement lens.
- 2 rolls of film.
- 1 mud flap.
- 6 tear-offs.

447908 • One size • Clear (00)

\$XXXX



CAN-AM WORKS SINGLE LENS TEAR-OFF BY SCOTT

- 1 clear replacement lens.
- 6 tear-offs.
- 2 posts included.

447910 • One size • Clear (00)

\$XXXX



GOGGLES REPLACEMENT SINGLE LENS

- Impact-resistant polycarbonate.
- No Fog anti-fog lens treatment.

447905 • One size • Clear (00), Grey (09)

\$XXXX

448225 • One size • Mirror Silver (22)

\$XXXX



GOGGLES REPLACEMENT DUAL LENS

- Impact-resistant polycarbonate.
- No Fog anti-fog lens treatment.

447906 • One size
Clear (00), Pink (36)

\$XXXX

GLOVES

NEW X-RACE GLOVES

- Air mesh panels for ventilation and mobility.
- Double Clarino¹ layer at palm and thumb for extra durability and comfort.
- Pre-curved design.
- Silicone fingertip for better grip.
- Direct-injection details on back hand.
- Hook-and-loop wrist closure system.

Air Mesh, Spandex, Clarino¹

MEN'S

446306
XS, S, M, L, XL, 2XL
Red (30), Blue (80)

\$XXXX



LADIES'

446311
S, M, L, XL, 2XL
Turquoise (Aqua) (76),
Black (90)

\$XXXX



NEW ADVENTURE TEAM GLOVES

- Spandex construction for flexibility.
- Chamude palm.
- Pre-curved design.
- Non-fading sublimated graphics.
- Slip-on gloves.
- Welded logo.
- Silicon print at inner fingers.

Shell: Spandex, Chamude, Polyester

446305 • S, M, L, XL, 2XL, 3XL
Red (30)

\$XXXX



MOSSY OAK CAMO GLOVES

- Matches ATV/Side-by-side Mossy Oak Break-Up Country Camo pattern.
- 100g insulation keeps out the cold.
- Quick, easy forefinger trigger[®] access.
- Extra-durable leather-layered palm provides added grip.
- Hipora[™] waterproof/windproof/

85% Polyester, 15% Leather
Insulation: 100% Polyester

286572 • M, L, XL, 2XL, 3XL
Mossy Oak Break-Up Country Camo (37)

\$XXXX

- breathable insert.
- Velcro[®] wrist adjustment.
- Pre-shaped fingers.
- Large gauntlet ensures proper jacket-sleeve overlap.
- * Forefinger area not completely waterproofed.



WINTER RIDING GLOVES AND MITTS

- mcFIT¹ technology to improve grip at palm.
- Extra warm nylon gloves with leather palm.
- Removable antibacterial, stay-dry moisture management lining.
- Gloves with visor-wiping cotton terry left thumb for clearing water, snow or fog.
- Reflective details.

Nylon, Leather
Insulation: Primaloft Gold

Gloves

286204
S, M, XL
Black (90)

\$XXXX



Mitts

286583
M, L, XL, 2XL
Black (90)

\$XXXX



mcFIT stands for Maximum Comfort Fit because the membrane and outer shell are laminated together. Gloves using this technology are more flexible and ultimately result in a better feel.

JUNIOR X CRUSH HELMET

- Advanced Plastic Composite Shell.
- Multi-density EPS liner.
- Ultra-plush removable/washable liners.
- Adjustable visor to protect from the elements.
- Multiple air vents help keep you cool and dry.
- Lightweight double-D chin strap.
- Ski-Doo and Can-Am stickers in the box.
- Optional breath deflector (sold separately).

Shell: ABS

448506 • S, M, L • Black with graphics (94)

\$XXX

DOT ECE22.05



CAN-AM JUNIOR TRAIL GOGGLES BY SCOTT

- Integrated custom painted frame and strap graphics.
- No Fog! anti-fog lens treatment.
- 100% plastic UV protected clear Lexan® lens.
- Multi-layer face foam.
- Durable anti-slip strap.

448512 • One size • Black (90)

\$XXX



BOY CHASE TEE

- Can-Am print at back.
- 100% Cotton
- 286489 • 7-8, 10-12, 14-16
- Red (30), Black (90)

\$XXX



GIRL CAN-AM HOODIE

- Can-Am print at back.
- 72% Cotton, 23% Polyester, 5% Spandex
- 286486 • 7-8, 10-12, 14-16 • Purple (40)

\$XXX



BAGS

CAN-AM SLAYER GEAR BAG BY OGIO

- Large main compartment with easy access to all gear.
- Large separated boot pocket.
- Zippered accessory pocket.
- Easy grab handles for transport.
- Detachable shoulder strap.
- Heavy-duty reinforced base
- Dimensions: 32" H x 16" W x 18" D (81 cm x 41 cm x 46 cm)

100% Polyester

469294 • One size • Black (90)

\$XXX



CAN-AM URBAN BACKPACK BY OGIO

- Airport security friendly protective laptop compartment.
- Padded iPad™/tablet/e-reader pocket.
- Dual side water bottle/accessory holders.
- Fully adjustable ergonomic shoulder straps.
- Front pocket with two padded accessory compartments and slip pocket.
- Dimensions: 19.5" H x 13.5" W x 9.5" D (50 cm x 34 cm x 24 cm).

100% Polyester

469293 • One size • Black (90)

\$XXX



HOW TO MEASURE

- For best results, have someone else take measurements.
- Measure body in underwear.
- Tape must be snug but not tight.
- If measurements fall between two sizes, order the larger size.

1 HEAD	Around your head, from the center of the forehead, above the ears and over the natural bump at the back of the head.
2 ARM LENGTH	Let the hands hang down on the side in a slightly bent position. Measure from the center of the back of your neck, along the length of your arm, to the wrist.
3 CHEST/BUST	Measure under your arms, around the fullest part of your chest.
4 WAIST	Measure around your natural waistline, keeping one finger between the tape and body.
5 HIPS	Across the fullest part of the seat.
6 INSEAM	Without shoes, from crotch to the floor.

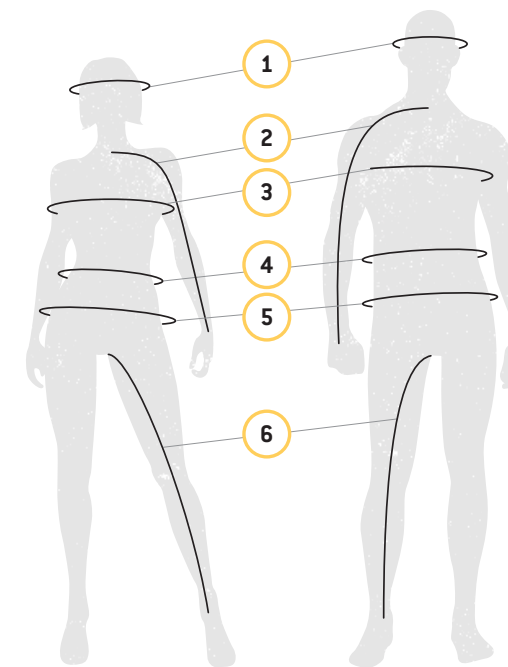

WHAT CODE REPRESENTS YOUR SIZE?

1. Find your size.
2. The corresponding code is **THE CODE** you use to complete the part number on your order.
Example: 440227__90 Size: M = Code "06", therefore 4402270690

SIZE	CODE	SIZE	CODE	SIZE	CODE	SIZE	CODE	SIZE	CODE	SIZE	CODE
One Size	00	XL	12	L/XL	73	11/12	56	10	30	32	38
XS	02	XLT	13	2	21	13/14	80	10.5	99	34	39
XS/S	90	2XL	14	3/4	79	14/16	50	11	31	36	40
S	04	3XL	16	5/6	52	4	23	12	32	38	41
M	06	4XL	18	6/8	48	6	25	13	33	40	42
MT	07	5XL	88	7/8	54	7	27	14	34	42	43
L	09	S/M	72	9/10	55	8	28	28	36	44	44
LT	10	M/L	91	10/12	49	9	29	30	37		

MEN'S—1.77 M - 1.83 M							
	XS	S	M	L	XL	2XL	3XL
CHEST	89-94	94-102	102-112	112-122	122-132	132-142	52-56
WAIST	74-79	79-86	86-97	97-107	107-117	117-127	46-50
HIPS	89-94	94-102	102-112	112-122	122-132	132-142	52-56
ARM LENGTH	79-81	81-84	84-86	86-89	89	89-91	35
INSEAM	80-81	81	81	81	81-82	82-83	32 1/2

LADIES'—1.64 M - 1.77 M							
	XS	S	M	L	XL	2XL	3XL
CHEST	81-86	86-91	91-99	99-107	107-114	114-124	124-134
WAIST	61-66	66-71	71-76	76-86	86-94	94-104	104-114
HIPS	86-91	91-97	97-102	102-112	112-119	119-132	132-140
ARM LENGTH	79	79-81	81	81-83	83	83-86	86
INSEAM	76	76	76	76	76	76-77	77

MEN'S GLOVES (MEASURE PALM WIDTH)						
	S	M	L	XL	2XL	3XL
CM	7.5	8.5	9.5	10.5	11.5	14

LADIES' GLOVES (MEASURE PALM WIDTH)					
	S	M	L	XL	2XL
CM	6.8	7.5	8.3	9	11.5

HELMETS							
	XS	S	M	L	XL	2XL	3XL
HEAD (CM)	53-54	55-56	57-58	59-60	61-62	65-66	65-66

JUNIOR HELMETS			
	S	M	L
HEAD (CM)	49-50	51-52	53-54

REMEMBER WHAT MADE YOU FALL FOR A CAN-AM VEHICLE?
Precisely engineered. Rigorously tested. Factory approved. The ultimate off-road experience continues with the Genuine Can-Am parts.

PARTS THAT SET THE STANDARD

2 YEARS WARRANTY ON ALL GENUINE CAN-AM PARTS

REGULAR MAINTENANCE ENSURES YOUR **TRAXTER** CAPABILITIES STAYS AT ITS PEAK.



KEEP AN EYE ON THESE COMPONENTS*

- | | | |
|----------------------------|----------------------------------|------------------------------------|
| 1 OIL FILTER 420256188 | 6 DRIVE BELT 422280654/422280280 | 11 BALL JOINTS 706202044/706202045 |
| 2 ENGINE OIL SEE P.82 | 7 BRAKE PADS SEE P.78 | 12 SPARK PLUG 707000246 |
| 3 FUEL FILTER 709000330 | 8 BOOT KITS SEE P.78 | 13 BATTERY 410301203 |
| 4 AIR FILTER 715900394 | 9 WHEEL BEARINGS 293350118 | |
| 5 CVT AIR FILTER 706600156 | 10 A-ARM BUSHINGS 703500875 | |

*Refer to periodic maintenance chart for proper intervals.

Some products shown may not be available or homologated in your country. Contact your BRP dealer for local details.



OIL FILTER

420256188



O-RING (DRAIN PLUG)

(Not illustrated)
420552280

OIL FILTER COVER GASKET

(Not illustrated)
420230920

SEE OIL & MAINTENANCE PRODUCTS AT PAGE 84,
INCLUDING COMPLETE OIL CHANGE KIT.

PREMIUM AIR FILTER

- Prevents airborne contaminants from reaching your engine.
 - Protects internal components against premature wear.
 - Genuine BRP air filters ensure absolute compatibility and a perfect fit.
- 715900394



SPARK PLUG

707000246



FUEL FILTER

(Not illustrated)
Traxter, Traxter MAX
709000330
EVAP models only
709000100

CVT AIR FILTER

(Not illustrated)
706600156

VISIT THE [CAN-AMOFFROAD.COM](https://can-amoffroad.com) PARTS & MAINTENANCE SECTION TO SEE THE FULL LINE OF GENUINE CAN-AM PARTS.

Note: Please contact your dealer or visit our online store at can-amoffroad.com for suggested retail prices regarding Genuine Can-Am Parts.

PREMIUM DRIVE BELT

- Premium drive belt calibrated to maximize your vehicle's performance.
- Aramid tensile cords used in construction for extra long life and dependability.
- Built with distinctive durability features for off-road riding.

422280654 • HD8, HD10
422280280 • HD5



PULLER/LOCKING TOOL

- (Not illustrated)
- Allows to spread the secondary clutch open for easy belt replacement.
- Locks engine at TDC for maintenance tasks.

529036098 • HD5
708200686 • HD8, HD10 Driven Pulley Adaptor
529036352 • HD8, HD10 Driven Pulley Adaptor

CVT GASKET COVER

(Not illustrated)
420630292 • HD5
420450400 • HD8, HD10

CV BOOT KITS

- Come with clamps and grease.
 - Genuine BRP CV Boot Kits ensure absolute compatibility and a perfect fit.
- 705401345 • Front wheel side
705401355 • Front differential Side
705501864 • Rear



PERFORMANCE HALF SHAFT

- (Not illustrated)
- High-performance design ideal for off-road use with superior protection in mud riding usage.
- Includes CVs, shaft and Boots with the best suited geometry for your Can-Am vehicle.

Traxter/Traxter XMR
705402420 • Front
705502594 • Rear

PREMIUM HALF SHAFT

- Premium quality design ideal for off-road, heavy-duty and low speed torque usage.
- Includes CVs, Shaft and Boots with the best suited geometry for your Can-Am vehicle.

HD5 HD10, HD8, HD5 XTP models HD10, HD8 (including XTP)
705502478 • Rear Left 705401937 • Front Left 705402353 • Front 705502451 • Rear
705502479 • Rear Right 705401936 • Front Right



A-ARM BUSHING KIT

- This bushing kit includes 2 bushings, a sleeve and a wearplate, as illustrated. All you need to renew your suspension A-Arms
- 703500875



WHEEL BEARING

- (Not illustrated)
 - Sealed bearings for additional protection from water and dirt.
- 293350118

BALL JOINTS

- Robust design for off-road usage and sealed for prolonged durability.
- 706202044 • Upper
706202045 • Lower



METALLIC BRAKE PAD KIT

- Built strong to last long – heavy-duty construction stands up to hard braking.
- Designed to handle demanding riding conditions with challenging braking environments such as mud and dunes.
- Created specifically for use with Can-Am vehicles.

715900379 • HD5, HD8, HD10 - Front Left
715900381 • HD8, HD10 (Single piston caliper) - Rear Left
715900386 • HD8 MAX, HD10 MAX (Double piston caliper) - Rear Left
715900380 • HD5, HD8, HD10 - Front Right & Rear Right (HD5 only)
715900382 • HD8, HD10 - (Single piston caliper) Rear Right
715900387 • HD8 MAX, HD10 MAX - (Double piston caliper) Rear Right

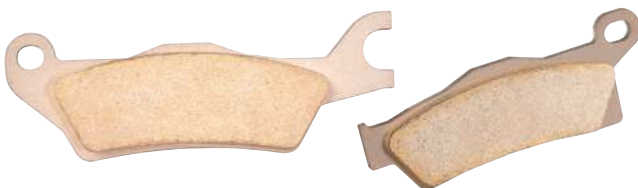

YUASA BATTERIES

- Top of the line models from the leading preferred original equipment battery supplier in North America.

18 Amps. Wet • (YTX20L-BS)
410301203



30 AH BATTERY UPGRADE

- Requires 1 additional bolt and 1 washer (207562054 & 234062410).
- Please refer to your user manual for removal and installation.
- Stock on XT & XT CAB.

515176151 • Base & DPS models



CHOOSING THE RIGHT DRIVE BELT CAN IMPACT POWER & PERFORMANCE

WHAT MAKES CAN-AM BELTS STAND OUT?

One essential material stands among our drive belt components: **PBO Fiber**.

PBO Fiber is the next generation super fiber with excellent thermal stability, great abrasion resistance, and moreover, almost twice the strength and modulus of Aramid fiber.

- > We partner with the best manufacturers in the powersports industry to offer you **unique drive belts** with consistent quality.
- > The **100% cutting-edge PBO high-tensile strength polymer fiber** construction offers high-temperature robustness and prolonged durability.

- > Our engineering teams have perfectly integrated and tested each drive belt to **provide quick throttle response, powerful acceleration, top speed and consistent shifting performance.**
- > We aim at delivering the highest levels of performance and longevity based on **your vehicle's specific end-use and calibration.**

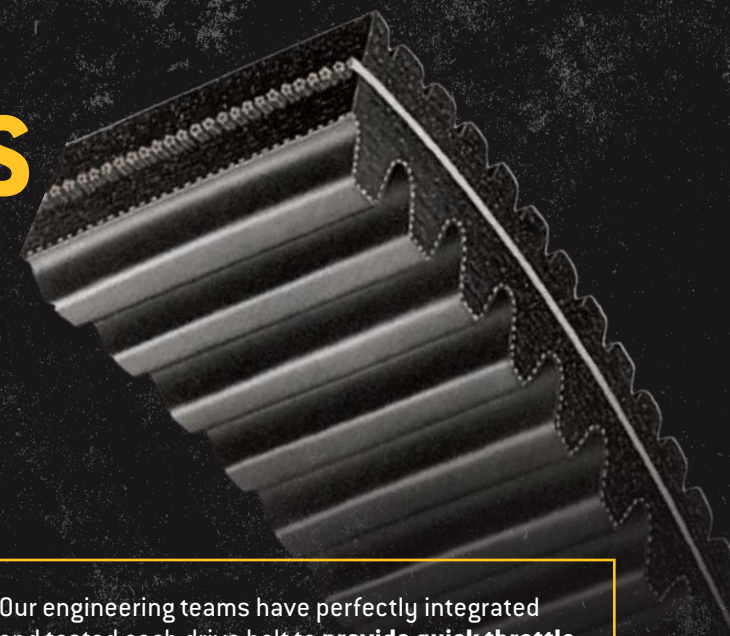

CAN-AM BELT CONSTRUCTION VS. COMPETITORS

MODULUS & TENSILE STRENGTH

Based on Dynamometer testing, PBO surpasses Kevlar and Carbon Fiber materials in every way.

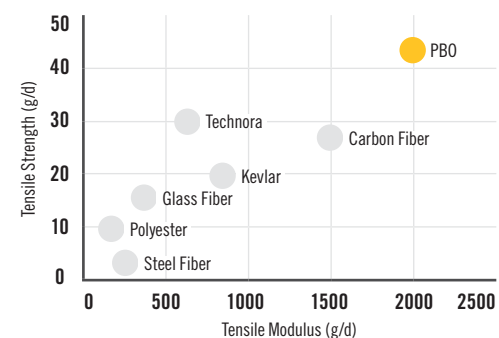

DURABILITY COMPARISON

Compared to Can-Am's Performance Drive Belt (100% PBO - 422280364).

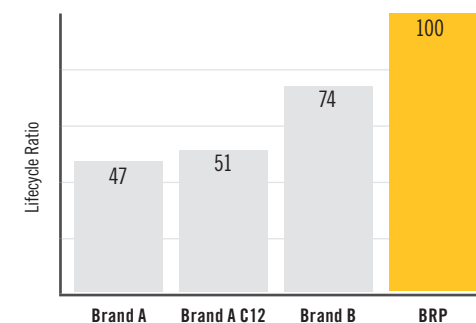

"I HAVE TESTED ALL BELTS OUT THERE, AND CAN-AM'S DRIVE BELTS ARE THOSE I'M RELYING ON TO WIN RACES."

PHIL BLURTON

2017 & 2018 UTV WORLD CHAMPIONSHIP WINNER
2017 BITD UTV PRO PRODUCTION TURBO CHAMPION

Note: Please contact your dealer or visit our online store at can-amoffroad.com for suggested retail prices regarding Genuine Can-Am Parts.

Some products shown may not be available or homologated in your country. Contact your BRP dealer for local details.



Rotax ACE triple-cylinder engine



Rotax V-twin engine



KYLE CHANEY
2017 TORC PRO MOD UTV CHAMPION



PHIL BLURTON
2017 BITD UTV PRO PRODUCTION TURBO CHAMPION

WHY XPS OIL IS THE PERFECT FIT FOR YOUR ROTAX ENGINE?

Whether you purchased it as a necessity for transportation, or the pure exhilaration of performance, your Can-Am is an investment – get the most out of it. XPS lubricants are the only lubricants specifically engineered to do that with your Rotax-powered Can-Am vehicles.

XPS oil meets the demands of high-performance off-road engines, including turbo and supercharged engines. XPS oil is formulated specifically for the higher stress these engines experience.

UNMATCHED RELIABILITY

Get the most out of every mile on every ride.

ULTIMATE PERFORMANCE

Engineered to match the advanced performance of Rotax Engines.

MADE FOR THIS

Developed with Rotax engines to deliver the best performance and lubrication in all conditions.



XPS OIL HAS UNDERGONE RIGOROUS TESTING IN WORST CASE SCENARIOS TO PROVE ITSELF AND WILL BE USED BY MANY CAN-AM OFF-ROAD RACERS THIS YEAR.

VISIT THE CAN-AMOFFROAD.COM PARTS & MAINTENANCE SECTION TO SEE THE FULL LINE OF XPS LUBRICANTS.

XPS IS A COMPLETE RANGE OF PERFORMANCE PRODUCTS DESIGNED TO PROTECT YOUR VEHICLE AND EXTEND ITS LIFETIME.

EACH HAS BEEN RIGOROUSLY DEVELOPED, TESTED AND APPROVED. TAKE THE GUESSWORK OUT OF YOUR VEHICLE MAINTENANCE AND GET TRUE XPS PEACE OF MIND.



XPS ENGINE OILS

NEW 4T 10W-50 SYNTHETIC OIL

- Engineered for heavy-duty and high-performance 4-stroke engines, including turbocharged, supercharged and racing engines.
- Formulated using carefully selected and strenuously tested base stocks and custom additives.
- Offers thick film strength to protect bearings, and a proven high-temp detergency to minimize deposits, prevent shear, provide thermal stability, and combat fuel dilution to ensure maximum performance from your engine.

946 ml 3.785 L
779234 • US 779235 • US
779240 • Europe 779241 • Europe



4T 0W-40 SYNTHETIC OIL

- 4-stroke engines powering recreational vehicles through mud, snow and water withstand a lot of high RPM and high load abuse, and this full synthetic oil is carefully engineered to provide the best protection for high-performance ATVs and SSVs.
- Its wide operating temperature range, additional corrosion protection, and engineered detergency make this oil the best choice for any powersport vehicle with a 4-stroke engine used in cold weather.

946 ml 3.785 L
779139 • US 779140 • US
779286 • Europe 779287 • Europe



4T 5W-40 SYNTHETIC BLEND OIL

- This synthetic blend is the oil of choice for owners of high-performance vehicles with a 4-stroke engine, including turbo or supercharged engines requiring carefully engineered friction.
- Combining the finest quality synthetic base stocks with extreme-tested synthetic additives, it provides superior engine and transmission protection against rust and corrosion compared to conventional engine oils, and optimum wet clutch operation for smooth and positive shifting with better cold start protection than 10W oils.

946 ml 3.785 L
779133 • US 779134 • US
779290 • Europe 779291 • Europe



LUBRICANTS

SYNTHETIC GEAR OIL

- Uses custom additives to provide the best performance in Visco-Lok & Smart-Lok differentials.
- Allows higher loads, superior shear stability and reduced oxidation.
- Exceptional wear protection and superior performance at all operating temperatures.
- 946 ml

75W-90 75W-140
779158 • US 779160 • US
779212 • Europe 779215 • Europe



SYNTHETIC GREASE SUSPENSION

- Designed to work specifically with the components found in Can-Am vehicle suspensions.
- It is highly stable and offers optimal lubrication at both extreme cold and high temperatures while protecting suspension components from dirt and moisture, as well as corrosion under extreme washout conditions.
- 400 g

779163



ANTI-CORROSIVE LUBRICANT

- Multipurpose lubricant that can also be used to prevent rust, corrosion and moisture intrusion.
- It contains extreme pressure additives that work as an all-around lubricant for just about anywhere lubrication is needed.
- 340 g

779168 • US
779224 • Europe



EXTENDED LIFE PRE-MIXED COOLANT

- XPS Antifreeze/Coolant contains the correct dilution and the necessary additives to prevent corrosion and inhibit cavitation in BRP cooling systems.
- Long-life, 5-year formula specially formulated for BRP vehicles.
- Superior heat transfer.
- Ideal replacement for vehicles that normally use a 2-year antifreeze/coolant (green), 5-year (orange).
- 946 ml

779150



Note: Please contact your dealer or visit our online store at can-amoffroad.com for suggested retail prices of XPS products. Some products shown may not be available or homologated in your country. Contact your BRP dealer for local details.

Note: Please contact your dealer or visit our online store at can-amoffroad.com for suggested retail prices of XPS products.

XPS MAINTENANCE PRODUCTS

DOT4 BRAKE FLUID

- Meets or exceeds all DOT3 and DOT4 brake fluid requirements.
- High-temperature formula resists fade, and also conditions seals and o-rings in braking system.
- 355 ml

779151 • US
779207 • Europe



RACING BRAKE FLUID

- Exceeds DOT4 brake fluid requirements for extreme conditions and competition use.
- Extreme, 579-degree boiling point temperature is ideal for high-demand competition conditions to combat brake fade.
- 355 ml

779152 • US
779209 • Europe



ENGINE OIL CHANGE KIT

- Ultra-convenient “all-in-one” oil change kit saves time and money.
- Includes XPS Synthetic or Synthetic Blend Oil, oil filter, o-rings and washer.

- 779256 • Synthetic Blend (5W-40 450 CC or less)
- 779257 • Full Synthetic (0W-40 450 CC or less)
- 779258 • Synthetic Blend (5W-40 500 CC or more)
- 779259 • Full Synthetic (0W-40 500 CC or more)
- 779252 • Full Synthetic (10W-50 500 CC or more)
- 779260 • Synthetic Blend (5W-40 900 ACE)
- 779261 • Full Synthetic (10W-50 900 ACE)



HIGH PERFORMANCE SUSPENSION FLUID

- A synthetic, fade-free formula for servicing FOX® shocks.
- Specially formulated for high-demand or racing application.
- Ultra high VI shock oil.
- Engineered viscosity for optimized performance with FOX® shocks valving.
- 946 ml

779153 • US
779210 • Europe



CARBON FREE FUEL TREATMENT

- Combination of a fuel treatment and a fuel system cleaner that can be used periodically to restore lost starting or throttle performance, as well as maintain fuel system integrity and keep internal engine parts clean.
- It treats fuel for storage and addresses the moisture problems inherent in today's Ethanol-blended fuels, keeping ferrous and soft metal parts clean and free of corrosion.
- Uses patented, state-of-the-art additives.
- Cleans valves, sticky rings and combustion chamber.
- 355 ml

779169 • US
779220 • Europe



FUEL TREATMENT CARBURETOR CLEANER

- Complete fuel treatment specially formulated to prevent small engine problems caused by Ethanol-blended fuels.
- It removes fuel system gum and varnish that may have accumulated during storage, stabilizes fuel against breakdown for 12 months or more, and adds corrosion protection from moisture for short- and long-term storage.
- It also helps restore throttle response and easy starting.
- It can be used periodically to maintain fuel system integrity, keep carburetor jets clean, and also combat moisture problems caused by Ethanol-blended fuels to keep ferrous and soft metal parts clean and free of corrosion.
- 355 ml

779172 • US
779184 • Europe



FUEL STABILIZER

- Ethanol-compatible and will stabilize fuel in your tank to keep it from breaking down and causing hard starting, throttle hesitation and poor run quality.
- Ethanol attracts moisture, and this product contains powerful anti-corrosion additives to protect fuel system components.
- Prevents problems associated with E10 fuels.
- 236 ml

779171 • US
779183 • Europe



XPS CLEANERS

SPRAY CLEANER & POLISH

- Removes dirt, grease, road grime and water marks easily and quickly.
- Non petroleum based formula will not harm plastic finishes.
- 340 g

219702844



BRAKES & PARTS CLEANER

- A concentrated blend of solvents with a powerful blasting spray that effectively removes grease, grime, brake fluid and other contaminants from brake components and metal parts without the need for disassembly.
- Evaporates instantly and completely, leaving no residue to hinder performance.
- Contains no ozone depleters.
- 397 g

219701776



OFF-ROAD VEHICLE WASH

- A biodegradable non-toxic cleaner that removes mud and dried-on dirt from your off-road vehicle.
- Whether grimy from the track, the woods or the fields, this cleaner will leave your off-road vehicle sparkling.
- When used as directed, XPS Wash is safe for all off-road vehicle finishes.
- 946 ml

219701702



MICROFIBER TOWELS

- The latest in high-quality detailing towels.
- Made up of extremely fine fibers, their soft surfaces have been perfected for drying and polishing painted, gel coated and hard shiny surfaces.
- They are so absorbent they hold up to seven times their weight in water.
- Machine washable means they can be used over and over again.
- Pack of 2.

219701759



ski-doo LYNX SEA-DOO EVINRUDE ROTAX Can-am

Note: Please contact your dealer or visit our online store at can-amoffroad.com for suggested retail prices of XPS products. Some products shown may not be available or homologated in your country. Contact your BRP dealer for local details.